



MODEL:

DRPC-140-EHL Series

Fanless embedded system, Intel® Celeron® J6412 2.0GHz (up to 2.6GHz, 4-Core, TDP 10W), four RS-232/422/485, four USB 3.2, two HDMI, two 2.5GbE LAN, 12-bit DIO, CAN-Bus, 12~24V DC and RoHS

User Manual

Revision

Date	Version	Changes
Oct. 25, 2023	1.00	Initial release

Copyright

COPYRIGHT NOTICE

The information in this document is subject to change without prior notice in order to improve reliability, design and function and does not represent a commitment on the part of the manufacturer.

In no event will the manufacturer be liable for direct, indirect, special, incidental, or consequential damages arising out of the use or inability to use the product or documentation, even if advised of the possibility of such damages.

This document contains proprietary information protected by copyright. All rights are reserved. No part of this manual may be reproduced by any mechanical, electronic, or other means in any form without prior written permission of the manufacturer.

TRADEMARKS

All registered trademarks and product names mentioned herein are used for identification purposes only and may be trademarks and/or registered trademarks of their respective owners.

Manual Conventions



WARNING

Warnings appear where overlooked details may cause damage to the equipment or result in personal injury. Warnings should be taken seriously.



CAUTION

Cautionary messages should be heeded to help reduce the chance of losing data or damaging the product.



NOTE

These messages inform the reader of essential but non-critical information. These messages should be read carefully as any directions or instructions contained therein can help avoid making mistakes.



HOT SURFACE

This symbol indicates a hot surface that should not be touched without taking care.

Table of Content

1 INTRODUCTION.....	1
1.1 OVERVIEW.....	2
1.2 FEATURES.....	2
1.3 TECHNICAL SPECIFICATIONS	3
1.4 FRONT PANEL.....	4
1.5 TOP PANEL	5
1.6 PHYSICAL DIMENSIONS	6
2 UNPACKING	7
2.1 ANTI-STATIC PRECAUTIONS	8
2.2 UNPACKING PRECAUTIONS.....	8
2.3 UNPACKING CHECKLIST	9
3 INSTALLATION	11
3.1 INSTALLATION PRECAUTIONS	12
3.2 COVER REMOVAL.....	13
3.3 MEMORY INSTALLATION.....	13
3.4 STORAGE INSTALLATION	15
3.4.1 M.2 Installation.....	15
3.4.2 HDD/SSD 2.5-inch Installation	16
3.5 WI-FI MODULE INSTALLATION (OPTIONAL).....	17
3.6 COVER INSTALLATION	18
3.7 MOUNTING THE SYSTEM	18
3.7.1 DIN Rail Installation.....	18
3.7.2 Wall Mounting Installation	20
3.8 EXTERNAL PERIPHERAL INTERFACE CONNECTORS.....	21
3.8.1 HDMI Connector	21
3.8.2 LAN Connectors.....	21
3.8.3 Power Connector	23
3.8.4 Remote Power Connector	23

3.8.5 DB-9 RS-232/422/485 Serial Port Connection.....	24
3.8.6 USB Connectors.....	25
3.9 POWERING ON/OFF THE SYSTEM	26
3.10 AVAILABLE DRIVERS	27
3.10.1 Driver Download	28
4 SYSTEM MOTHERBOARD	30
4.1 LAYOUT.....	31
4.2 PERIPHERAL INTERFACE CONNECTORS.....	32
4.2.1 AT/ATX Power Mode Setting	33
4.2.2 Reset Button Mode Setting.....	33
4.2.3 DIO and CAN Bus Connector.....	34
4.3 INTERNAL INTERFACE CONNECTORS	35
4.3.1 Clear CMOS Button Connector.....	36
4.3.2 Case Open Circuit Setting.....	37
4.3.3 Flash Descriptor Override Setting Jumper.....	38
4.3.4 RTC Battery Connector.....	39
4.3.5 Buzzer Connector.....	40
4.3.6 DDR4 SO-DIMM Socket.....	42
4.3.7 Mini SATA Connector.....	43
4.3.8 SPI TPM Connector.....	44
4.3.9 Flash SPI ROM Connector	45
4.3.10 I ² C Connector	46
4.3.11 EC ROM Debug Connector.....	47
4.3.12 Internal USB 2.0 Connectors.....	48
4.3.13 SMBUS (2.0) Connector	49
4.3.14 M.2 A-key Slot.....	50
4.3.15 M.2 M-key Slot.....	52
5 BIOS.....	54
5.1 INTRODUCTION.....	55
5.1.1 Starting Setup.....	55
5.1.2 Using Setup	56
5.1.2.1 Keyboard Navigation	56
5.1.2.2 Touch Navigation	57

DRPC-140-EHL

5.1.3	<i>Getting Help</i>	58
5.1.4	<i>Unable to Reboot after Configuration Changes</i>	58
5.1.5	<i>BIOS Menu Bar</i>	58
5.2	MAIN.....	59
5.3	ADVANCED.....	62
5.3.1	<i>CPU Configuration</i>	63
5.3.2	<i>Trusted Computing</i>	67
5.3.3	<i>RTC Wake settings</i>	68
5.3.4	<i>F81966 Super IO Configuration</i>	69
5.3.4.1	<i>Serial Port 1 Configuration</i>	70
5.3.4.2	<i>Serial Port 2 Configuration</i>	71
5.3.4.3	<i>Serial Port 3 Configuration</i>	72
5.3.4.4	<i>Serial Port 4 Configuration</i>	73
5.3.5	<i>ENE KB9068 H/W Monitor</i>	75
5.3.6	<i>Serial Port Console Redirection</i>	76
5.3.6.1	<i>Console Redirection Settings</i>	77
5.3.7	<i>NVMe Configuration</i>	79
5.4	CHIPSET	80
5.4.1	<i>System Agent (SA) Configuration</i>	81
5.4.1.1	<i>Memory Configuration</i>	82
5.4.1.2	<i>Graphics Configuration</i>	83
5.4.2	<i>PCH-IO Configuration</i>	84
5.4.2.1	<i>PCI Express Configuration</i>	87
5.4.2.2	<i>PCI Express Root Port Setting</i>	88
5.4.2.3	<i>SATA Configuration</i>	90
5.4.2.4	<i>HD Audio Configuration</i>	91
5.5	SECURITY.....	92
5.6	BOOT.....	94
5.6.1	<i>Boot Configuration</i>	94
5.6.2	<i>Boot Option Priorities</i>	95
5.7	SAVE & EXIT	96
A.1	SAFETY PRECAUTIONS	99
A.1.1	<i>General Safety Precautions</i>	99
A.1.2	<i>Anti-static Precautions</i>	100
A.1.3	<i>Product Disposal</i>	101

A.2 MAINTENANCE AND CLEANING PRECAUTIONS 102

 A.2.1 *Maintenance and Cleaning*..... 102

 A.2.2 *Cleaning Tools*..... 102

List of Figures

Figure 1-1: DRPC-140-EHL Series.....	2
Figure 1-2: Front Panel	4
Figure 1-3: Top Panel	5
Figure 1-4: Physical Dimensions	6
Figure 3-1: Remove the Cover	13
Figure 3-2: Open the handles of the Memory Slot	14
Figure 3-3: Insert the Memory Module.....	14
Figure 3-4: Press down the Memory Module	15
Figure 3-5: Inserting the M.2 Module	15
Figure 3-6: Securing the M.2 Module.....	16
Figure 3-7: HDD Installation	16
Figure 3-8: Wi-Fi Module Installation.....	17
Figure 3-9: Cover Installation	18
Figure 3-10: DIN Rail Mounting Bracket Installation.....	19
Figure 3-11: Attach the Mounting Bracket to the DIN Rail	19
Figure 3-12: Mounting the System.....	20
Figure 3-13: Mounting Bracket Retention Screw	21
Figure 3-14: HDMI Connection	21
Figure 3-15: LAN Connection	22
Figure 3-16: RJ-45 Ethernet Connector	22
Figure 3-17: Power Connector	23
Figure 3-18: Remote Power Connector	24
Figure 3-19:: DB-9 RS-232/422/485 Serial Port Connector	25
Figure 3-20:: Serial Device Connection.....	25
Figure 3-21: USB Connection.....	26
Figure 3-22: Power Input.....	26
Figure 4-1: Connector and Jumper Locations.....	31
Figure 4-2: AT/ATX Power Mode Switch Locations	33
Figure 4-3: Reset Button Connector Location.....	34
Figure 4-4: Clear CMOS Location	36

Figure 4-5: Case Open Circuit Setting Locations.....	37
Figure 4-6: Flash Descriptor Override Setting Jumper Locations	38
Figure 4-7: Battery Connector Location.....	40
Figure 4-8: Buzzer Connector Location	41
Figure 4-9: DDR4 SO-DIMM Socket Location	42
Figure 4-10: Mini SATA Connectors Location	43
Figure 4-11: SPI TPM Connectors Location.....	44
Figure 4-12: Flash SPI ROM Connector Location	45
Figure 4-13: I²C Connector Location	46
Figure 4-14: EC ROM Debug Connector Location	47
Figure 4-15: Internal USB 2.0 Connectors Locations	48
Figure 4-16: SMBUS (2.0) Connector Location.....	49
Figure 4-17: M.2 A-key Slot Location.....	50
Figure 4-18: M.2 M-key Slot Location	52
Figure 5-1: BIOS Starting Menu	55
Figure 5-2: BIOS Navigation Keys	56
Figure 5-3: BIOS On-screen Navigation Keys	57
Figure 5-4: BIOS Options and Configured USB Ports	86

List of Tables

Table 1-1: Technical Specifications.....	4
Table 3-1: LAN1-3 2.5GbE RJ-45 Ethernet Connector LEDs.....	22
Table 3-2: Power Connector Pinouts.....	23
Table 3-3: RS-232/422/485 (COM1-4) Connector Pinouts.....	24
Table 4-1: Peripheral Interface Connectors.....	32
Table 4-2: AT/ATX Power Mode Switch Pinouts.....	33
Table 4-3: Reset Button Connector Pinouts.....	34
Table 4-4: Digital IO Connector Pinouts.....	35
Table 4-5: CAN Bus Connector Pinouts.....	35
Table 4-6: Internal interface Connectors.....	36
Table 4-7: Clear CMOS Pinouts.....	37
Table 4-8: Case Open Circuit Setting Pinouts.....	38
Table 4-9: Flash Descriptor Override Setting Jumper Pinouts.....	38
Table 4-10: Battery Connector Pinouts.....	40
Table 4-11: Buzzer Connector Pinouts.....	41
Table 4-12: SATA 6Gb/s Drive Connectors Pinouts.....	44
Table 4-13: SPI TPM Connector (TPM1) Pinouts.....	45
Table 4-14: Flash SPI ROM Connector Pinouts.....	45
Table 4-15: I ² C Connector Pinouts.....	46
Table 4-16: EC ROM Debug Connector Pinouts.....	47
Table 4-17: Internal USB 2.0 Connectors Pinouts.....	48
Table 4-18: SMBUS (2.0) Connector Pinouts.....	49
Table 4-19: M.2 A-Key Slot Pinouts.....	52
Table 4-20: M.2 M-key Slot Pinouts.....	53

BIOS Menus

BIOS Menu 1: Main (1/2).....	59
BIOS Menu 2: Main (2/2).....	59
BIOS Menu 3: Advanced	62
BIOS Menu 4: CPU Configuration (1/3).....	63
BIOS Menu 5: CPU Configuration (2/3).....	63
BIOS Menu 6: CPU Configuration (3/3).....	64
BIOS Menu 7: Trusted Computing	67
BIOS Menu 8: RTC Wake Settings.....	68
BIOS Menu 9: IT5571 Super IO Configuration	69
BIOS Menu 10: Serial Port 1 Configuration Menu	70
BIOS Menu 11: Serial Port 2 Configuration Menu	71
BIOS Menu 12: Serial Port 3 Configuration Menu	72
BIOS Menu 13: Serial Port 4 Configuration Menu	73
BIOS Menu 14: IT5571 H/W Monitor.....	75
BIOS Menu 15: Serial Port Console Redirection	76
BIOS Menu 16: COM Console Redirection Settings	77
BIOS Menu 17: NVMe configuration	79
BIOS Menu 18: Chipset	80
BIOS Menu 19: System Agent (SA) Configuration	81
BIOS Menu 20: Memory Configuration.....	82
BIOS Menu 21: Graphics Configuration	83
BIOS Menu 22: PCH-IO Configuration (1/2)	84
BIOS Menu 23: PCH-IO Configuration (2/2)	84
BIOS Menu 24: PCI Express Configuration	87
BIOS Menu 25: PCI Express Root Port Configuration	88
BIOS Menu 26: SATA Configuration.....	90
BIOS Menu 27: HD Audio Configuration	91
BIOS Menu 28: Security (1/2).....	92
BIOS Menu 29: Security (2/2).....	92
BIOS Menu 30: Boot	94

DRPC-140-EHL

BIOS Menu 31: Save & Exit.....96

Chapter

1

Introduction

1.1 Overview



Figure 1-1: DRPC-140-EHL Series

The DRPC-140-EHL series embedded system adopts Intel® Elkhart Lake processor with 8GB memory pre-installed (up to 32GB), and including two HDMI, two 2.5 GbE LAN ports, four USB ports, four RS-232 /422/485 (DB-9), two CAN-bus (DB9 with 2.5kV isolation), It is designed for harsh environment applications, and supports DIN rail mounting method.

1.2 Features

The DRPC-140-EHL Series features are listed below:

- Fanless design
- Intel® Celeron® J6412 2.0GHz (up to 2.6GHz, quad-core, TDP 10W)
- 1 x SO-DIMM DDR4 3200 (8GB pre-installed) (up to 32GB)
- 2 x 2.5 GbE LAN ports
- 4 x USB 3.2 GEN2
- 4 x RS-232/422/485 serial interfaces
- 1 x M.2 A Key 2230 (PCIe Gen3 x1/USB 2.0)
- 1 x M.2 M Key 2280 (PCIe Gen3 x2)
- 8-bit Digital I/O (4-in/ 4-out)
- 2 x CAN-bus (DB9 with 2.5kV isolation)

DRPC-140-EHL

1.3 Technical Specifications

The DRPC-140-EHL Series technical specifications are listed in (Table 1-1).

		DRPC-140-EHL
Chassis	Color	Black
	Dimension(WxDxH)(mm)	58.75 x 130 x 174
	System Fan	Fanless
	Chassis Construction	Extruded aluminum alloy
Processor	CPU	Intel® Celeron® J6412 2.0GHz (up to 2.6GHz, quad-core, TDP 10W)
	Chipset	SoC
Memory	System Memory	1 x SO-DIMM DDR4 3200 (8GB pre-installed) (up to 32GB)
Storage	Emmc	eMMC 5.1 64GB/128GB (Optional)
I/O Interfaces	USB	4 x USB 3.2 Gen2
	Ethernet	2 x 2.5 GbE by Intel® I225-V/I226-V controller
	Display	2 x HDMI (up to 4K@30Hz)
	COM	4 x RS-232/422/485 (DB-9)
	TPM2.0	1 x TPM (2 x10 pin) Intel PTT
	Other	1 x Power Button 1 x Reset Button 1 x AT/ATX Switch 1 x LED for Power (Green) 1 x LED for HDD (Yellow)
Expansions	M.2	1 x M.2 A Key 2230 (PCIe Gen3 x1/USB 2.0) 1 x M.2 M Key 2280 (PCIe Gen3 x2)
Power	Power Input	3-pin terminal block: 12-24V DC
	Remote Power	Terminal Block: 2-Pin
	Power Consumption	+12V@3.36A (Intel® Celeron® J6412 with 8GB memory)
Reliability	Mounting	DIN-Rail, Wall Mount
	Operating Temperature	-20 ~ 60°C with 0.7M/S air flow (M.2), 10% ~ 95%, non-condensing
	Storage Temperature	-20°C ~70°C with air flow (M.2), 10% ~ 90%, non-condensing

	Operating Shock	Half-sine wave shock 5G, 11ms, 100 shocks per axis (M.2)
	Operation Vibration	MIL-STD-810G 514.6C-1 (M.2)
	Weight (Net/Gross)	1.39kg /1.68 kg
	Safety / EMC	CE, FCC, UKCA
	Watchdog timer	Programmable 1~255 sec/min
OS	Supported OS	Microsoft® Windows® 10/11, Linux

Table 1-1: Technical Specifications

1.4 Front Panel

The front panel of the DRPC-140-EHL Series has the following features.

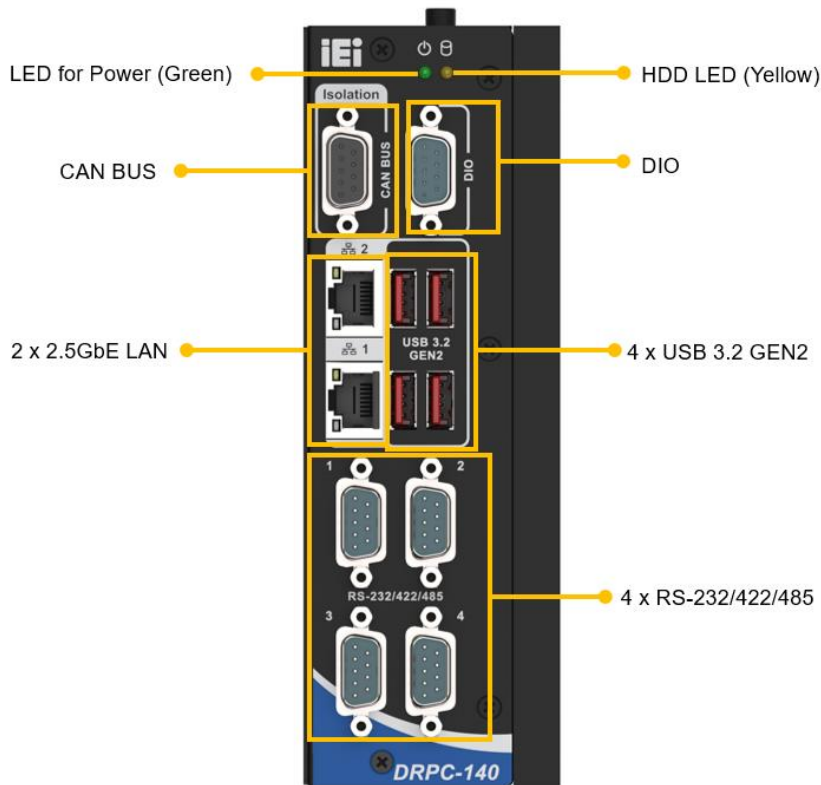

Figure 1-2: Front Panel

DRPC-140-EHL

1.5 Top Panel

An overview of the **DRPC-140-EHL** top panel is below

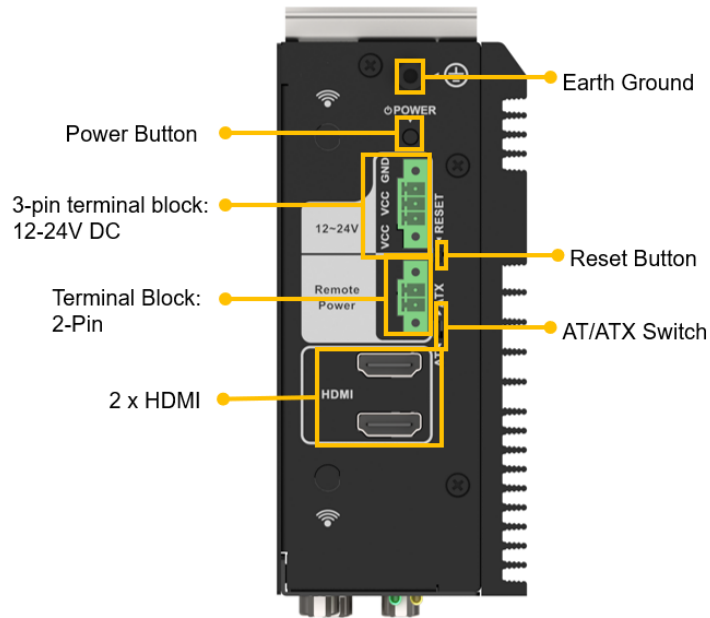

Figure 1-3: Top Panel

1.6 Physical Dimensions

The physical dimensions of the DRPC-140-EHL Series are shown in (Figure 1-4).

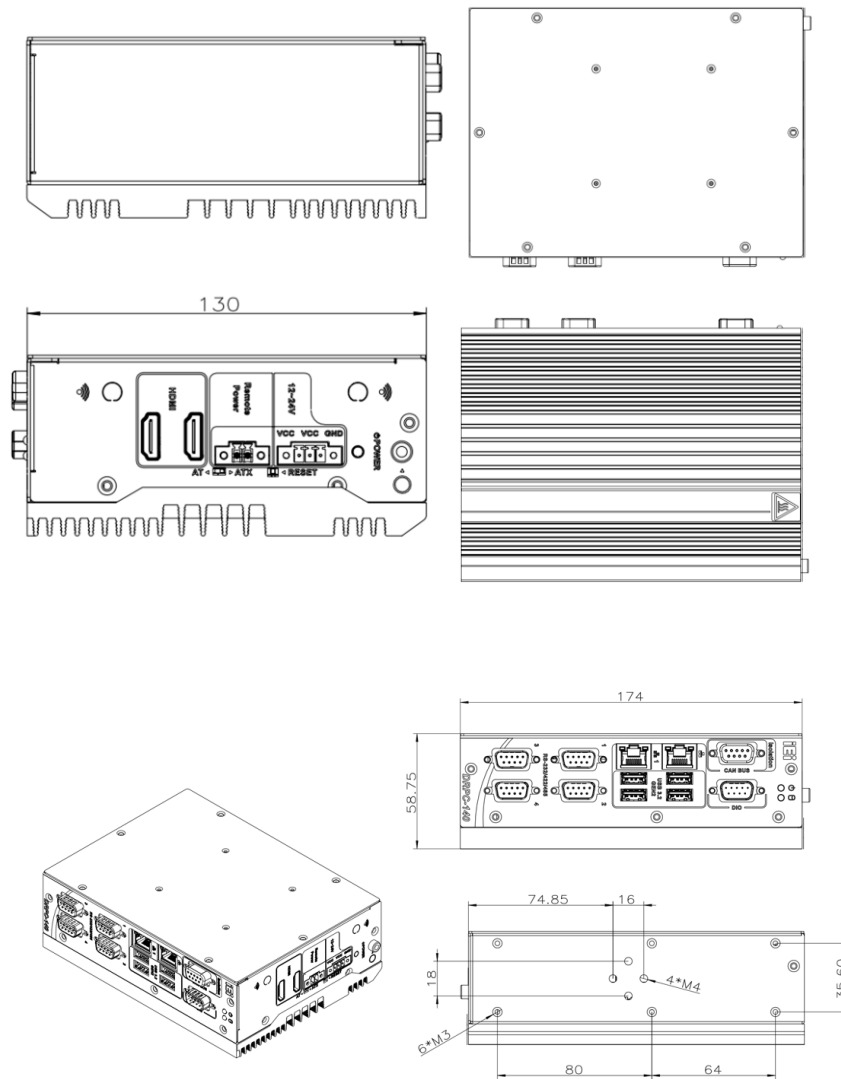

Figure 1-4: Physical Dimensions

Chapter

2

Unpacking

2.1 Anti-static Precautions



WARNING:

Failure to take ESD precautions during installation may result in permanent damage to the DRPC-140-EHL Series and severe injury to the user.

Electrostatic discharge (ESD) can cause serious damage to electronic components, including the DRPC-140-EHL Series. Dry climates are especially susceptible to ESD. It is therefore critical that whenever the DRPC-140-EHL Series or any other electrical component is handled, the following anti-static precautions are strictly adhered to.

- **Wear an anti-static wristband:** Wearing a simple anti-static wristband can help to prevent ESD from damaging the board.
- **Self-grounding:** Before handling the board touch any grounded conducting material. During the time the board is handled, frequently touch any conducting materials that are connected to the ground.
- **Use an anti-static pad:** When configuring the DRPC-140-EHL Series, place it on an anti-static pad. This reduces the possibility of ESD damaging the DRPC-140-EHL Series.

2.2 Unpacking Precautions

When the DRPC-140-EHL Series is unpacked, please do the following:

- Follow the anti-static precautions outlined in **Section 2.1**.
- Make sure the packing box is facing upwards that the DRPC-140-EHL Series does not fall out of the box.
- Make sure all the components shown in **Section 2.2** are present.



DRPC-140-EHL

2.3 Unpacking Checklist







 **NOTE:**

If some of the components listed in the checklist below are missing, please do not proceed with the installation. Contact the IEI reseller or vendor you purchased the DRPC-140-EHL Series from or contact an IEI sales representative directly. To contact an IEI sales representative, please send an email to sales@ieiworld.com.

The DRPC-140-EHL Series is shipped with the following components:

Quantity	Item and Part Number	Image
Standard		
1	DRPC-140-EHL Series	
1	DIN-Rail mounting kit	
1	Chassis screws	

The following table lists the optional items that can be purchased separately.

Optional	
Power Adapter (P/N: 63040-010060-120-RS)	
DC Power Cable (P/N: 32102-042300-100-RS)	
Wall mounting kit (P/N: 41420-0583C2-00-HF *2)	
Power cord, European standard, 1830 mm (P/N: 32702-000200-100-RS)	
Wireless kit (P/N: EMB-WIFI-KIT02I3-R10)	
20-pin Infineon SPI TPM2.0 module (P/N: TPM-IN03-R10)	
OS Image with Windows® 10 IoT Enterprise Entry 64-bit for DRPC-140-EHL Series, with DVD-ROM, RoHS DRPC-140-EHL-W10IoT21-E-R10	

Chapter

3

Installation

3.1 Installation Precautions



CAUTION:

The DRPC-140-EHL Series has more than one power supply connection point.

To reduce the risk of electric shock, disconnect all power sources before installing or servicing the DRPC-140-EHL Series.

During installation, be aware of the precautions below:

- **Read the user manual:** The user manual provides a complete description of the DRPC-140-EHL Series, installation instructions and configuration options.
- **DANGER! Disconnect Power:** Power to the DRPC-140-EHL Series must be disconnected during the installation process, or before any attempt is made to access the rear panel. Electric shock and personal injury might occur if the rear panel of the DRPC-140-EHL Series is opened while the power cord is still connected to an electrical outlet.
- **Qualified Personnel:** The DRPC-140-EHL Series must be installed and operated only by trained and qualified personnel. Maintenance, upgrades, or repairs may only be carried out by qualified personnel who are familiar with the associated dangers.
- **Air Circulation:** Make sure there is sufficient air circulation when installing the DRPC-140-EHL Series. The DRPC-140-EHL Series' cooling vents must not be obstructed by any objects. Blocking the vents can cause overheating of the DRPC-140-EHL Series. Leave at least 5 cm of clearance around the DRPC-140-EHL Series to prevent overheating.
- **Grounding:** The DRPC-140-EHL Series should be properly grounded. The voltage feeds must not be overloaded. Adjust the cabling and provide external overcharge protection per the electrical values indicated on the label attached to the back of the DRPC-140-EHL Series.

DRPC-140-EHL

3.2 Cover Removal

Before installing or maintaining the internal components, the cover must be removed from the DRPC-140-EHL. Follow the steps below to complete the task.

Step 1: Loosen the 6 screws on the cover.

Step 2: Take off the cover (**Figure 3-1**).



Figure 3-1: Remove the Cover

3.3 Memory Installation

The DRPC-140-EHL Series is pre-installed with an 8GB memory module. Users can add or replace memory with different capability by themselves. The installation procedures are described below.

Step 1: Open the two handles of the memory slot (**See Figure 3-2**).

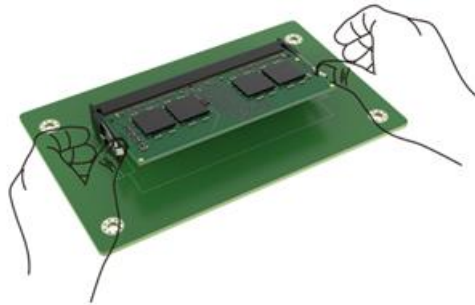

Figure 3-2: Open the handles of the Memory Slot

Step 2: Remove the old memory module and insert a new memory module. Carefully align the memory module with the notch on the memory socket (**Figure 3-3**).



Figure 3-3: Insert the Memory Module

Step 3: Once aligned, press down until the memory module is properly seated and the two handles fully clip into place (**See Figure 3-4**).

DRPC-140-EHL

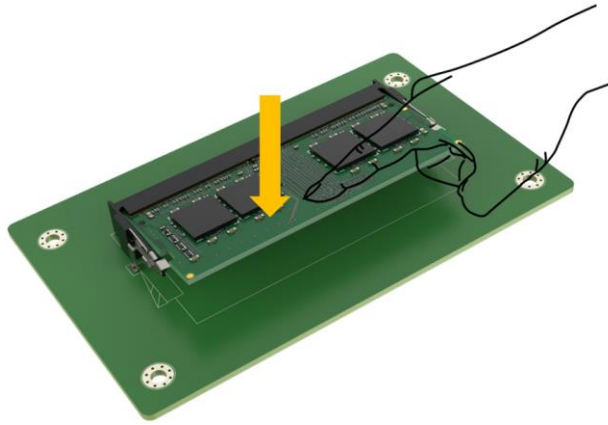

Figure 3-4: Press down the Memory Module

3.4 Storage Installation

The DRPC-140-EHL supports two types of storage: M.2 SSD and 2.5" SATA SSD/HDD. Follow the steps below to install storage devices.

3.4.1 M.2 Installation

Step 1: Locate the M.2 module slot. See section 4.3.14 and 4.3.15.

Step 2: Remove the retention screw secured on the motherboard.

Step 3: Line up the notch on the module with the notch on the slot. Slide the M.2 module into the socket at an angle of about 20° (Figure 3-5).

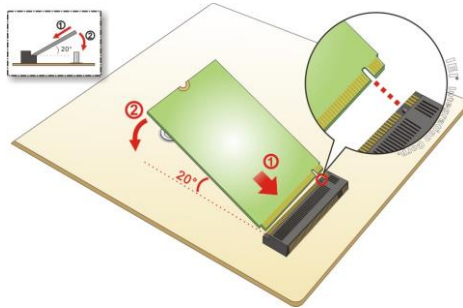

Figure 3-5: Inserting the M.2 Module

Step 4: Secure the M.2 module with the previously removed retention screw (Figure 3-6).

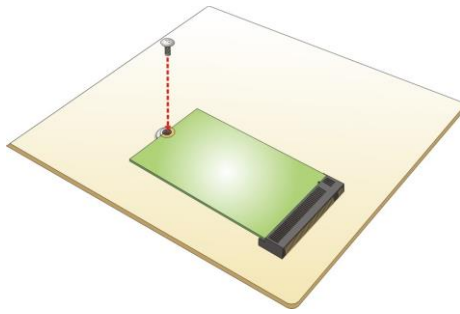

Figure 3-6: Securing the M.2 Module

3.4.2 HDD/SSD 2.5-inch Installation

Step 1: Remove the cover of the DRPC-140-EHL Series (see Section 3.2). Turn over the cover and place a 2.5-inch hard disk onto the cover. Fasten 4 screws to secure it.

Step 2: Connect the hard drive cable to the HDD and to the SATA connector on the motherboard. Install the cover back into the DRPC-140-EHL Series by using 6 screws (pay attention to the positioning stud). **(Figure 3-7).**

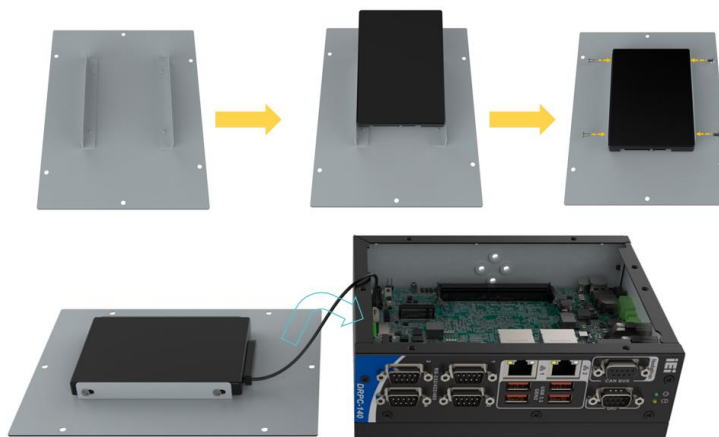

Figure 3-7: HDD Installation

DRPC-140-EHL

3.5 Wi-Fi Module Installation (Optional)

The Wi-Fi module is an optional accessory. You can purchase it from IEI or other providers. Note that you have to purchase Wi-Fi module, internal antenna and external antenna. It is suggested to purchase an internal antenna longer than 200mm.

To install the Wi-Fi module, follow the steps below.

Step 1: Remove the M.2 A key retention screw.

Step 2: Insert the Wi-Fi module (IEI P/N: EMB-WIFI-KIT02I3-R10, including one Intel AX210 wireless Bluetooth function module, two 300mm internal antennas and two 108mm external antennas) and secure the screw.

Step 3: Secure one end of the internal antenna to the Wi-Fi module.

Step 4: Knock out the reserved antenna holes on the chassis, and secure the other end of the internal antenna on the chassis.

Step 5: Install the external antennas (**Figure 3-8**)

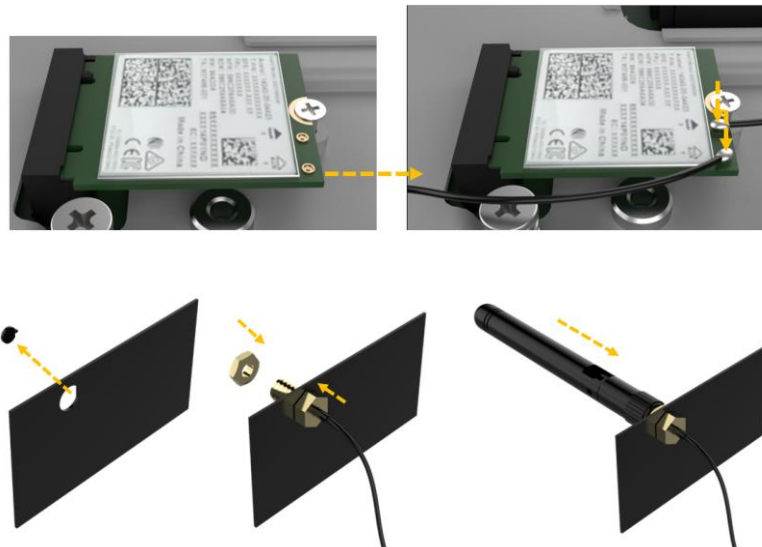

Figure 3-8: Wi-Fi Module Installation

3.6 Cover Installation

Install the cover, and fasten the 6 screws on the side. (Figure 3-9)



Figure 3-9: Cover Installation

3.7 Mounting the System

DRPC-140-EHL comes with standard DIN rail mounting bracket and optional wall mounting bracket. Follow these steps to install.

3.7.1 DIN Rail Installation

Step 1: Attach the supplied DIN rail mounting bracket to the rear panel of the embedded system. Secure the bracket to the embedded system with three retention screws (Figure 3-10)

DRPC-140-EHL

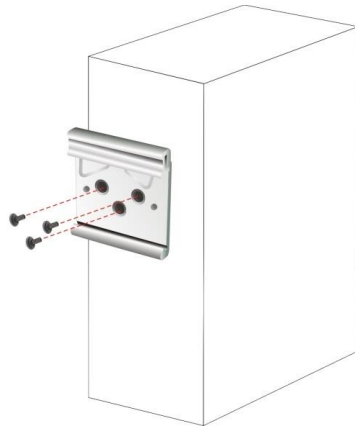

Figure 3-10: DIN Rail Mounting Bracket Installation



NOTE:

In the diagrams below, the DIN rail is already installed on a surface or on a chassis.

Step 2: Attach the upper edge of the mounting bracket to the DIN rail as shown in **Figure 3-11**

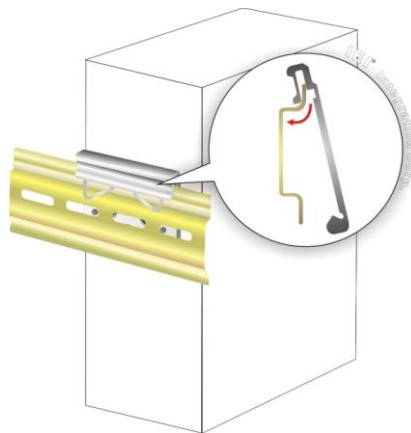

Figure 3-11: Attach the Mounting Bracket to the DIN Rail

Step 3: Push the system toward the DIN rail until the mounting bracket clips into place firmly (**Figure 3-12**)

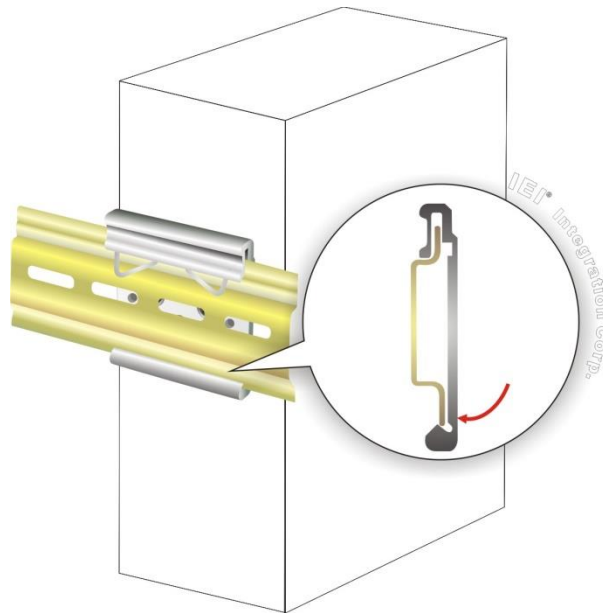

Figure 3-12: Mounting the System

3.7.2 Wall Mounting Installation

Step 1: Turn the embedded system over.

Step 2: Align the retention screw holes in each bracket with the corresponding retention screw holes on the side panel.

Step 3: Secure the brackets to the system by inserting retention screws into each bracket (**Figure 3-13**)

DRPC-140-EHL

Figure 3-13: Mounting Bracket Retention Screw

3.8 External Peripheral Interface Connectors

The DRPC-140-EHL Series has the following connectors. Detailed descriptions of the connectors can be found in the subsections below.

- HDMI
- Ethernet
- Power button
- Power DC jack
- USB
- RS-232/422/485
- CAN BUS
- DIO

3.8.1 HDMI Connector

To connect the HDMI devices, please plug in HDMI connector in the right direction as shown below:

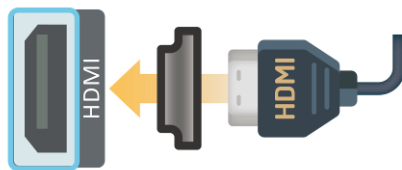

Figure 3-14: HDMI Connection

3.8.2 LAN Connectors

The LAN connectors allow connection to an external network

Step 1: Locate the RJ-45 connectors. The locations of the RJ-45 connectors are shown in **Chapter 1**

Step 2: Align the connectors. Align the RJ-45 connector on the LAN cable with one of the RJ-45 connectors on the **DRPC-140-EHL** Series. See

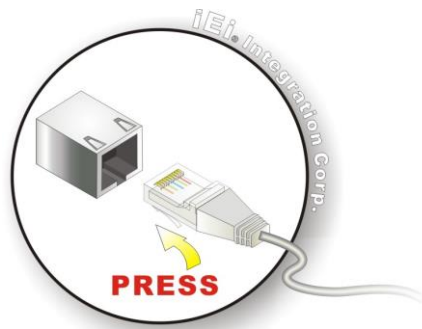

Figure 3-15: LAN Connection

Step 3: Insert the LAN cable RJ-45 connector. Once aligned, gently insert the LAN cable RJ-45 connector into the on-board RJ-45 connector

The RJ-45 Ethernet connector has two status LEDs, one green and one yellow. The green LED indicates activity on the port and the yellow LED indicates the port is linked.



Figure 3-16: RJ-45 Ethernet Connector

Activity/Link LED		Speed LED	
STATUS	DESCRIPTION	STATUS	DESCRIPTION
Off	No link	Off	10 Mbps connection
Yellow	Linked	Orange	1000 Mbps connection
Blinking	TX/RX activity	Green	2.5 Gbps connection

Table 3-1: LAN1-3 2.5GbE RJ-45 Ethernet Connector LEDs

DRPC-140-EHL

3.8.3 Power Connector

The power connector is a 3-pin Phoenix terminal connector on the rear panel that can directly connect to a power supply. The supported power input voltage is 12-24 VDC.

Pin	Description
1	12-24V
2	12-24V
3	GND

Table 3-2: Power Connector Pinouts

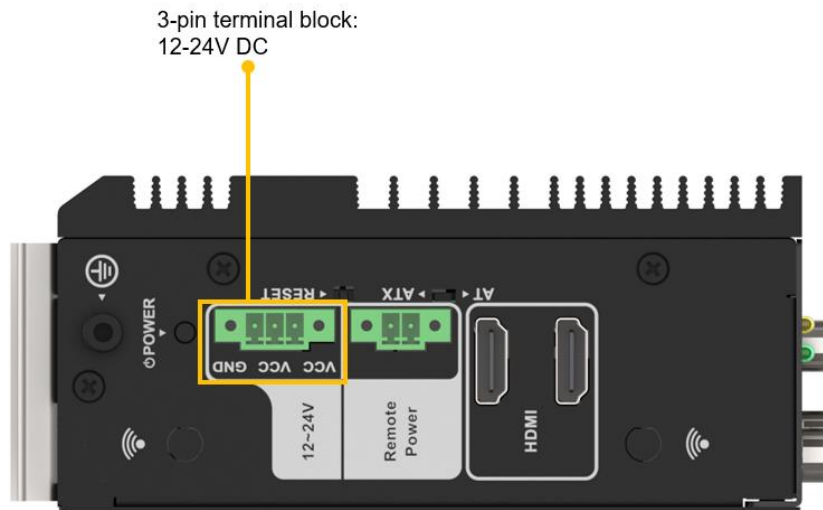

Figure 3-17: Power Connector

3.8.4 Remote Power Connector

This remote power switch connector can be connected to an external switch for remote control of power on and off (See Figure 3-18).

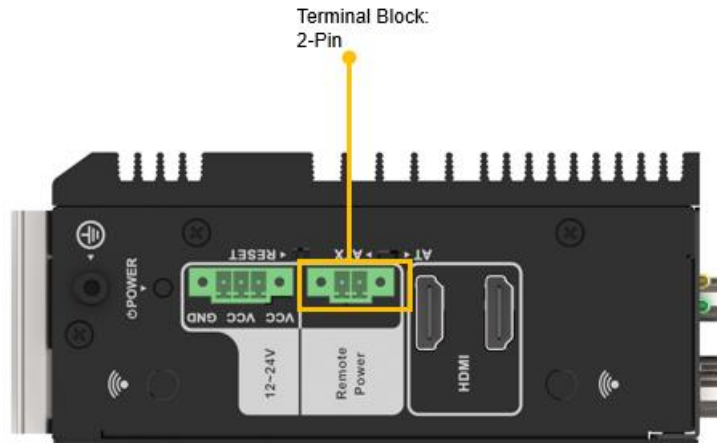

Figure 3-18: Remote Power Connector

3.8.5 DB-9 RS-232/422/485 Serial Port Connection

The DRPC-140-EHL Series has four RS-232/422/485 serial ports. The pinouts for the serial ports are listed in the **Table 3-3**.

PIN NO.	RS232	RS422	RS485
1	DCD#	TX-	TX-
2	RXD	TX+	TX+
3	TXD	RX+	
4	DTR#	RX-	
5	GND		
6	DSR#		
7	RTS#		
8	CTS#		
9	RI#		

Table 3-3: RS-232/422/485 (COM1-4) Connector Pinouts

DRPC-140-EHL

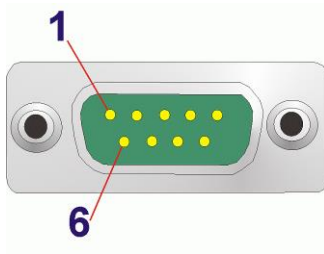

Figure 3-19:: DB-9 RS-232/422/485 Serial Port Connector

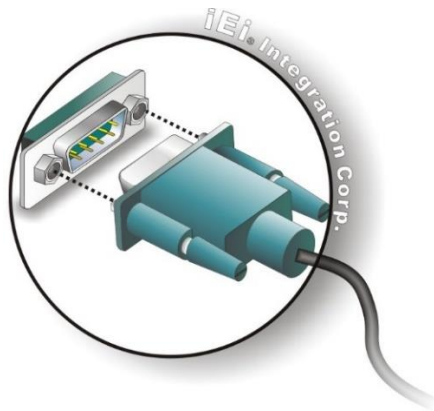

Figure 3-20:: Serial Device Connection

3.8.6 USB Connectors

The DRPC-140-EHL has four USB 3.2 ports. To connect a USB device, please follow the instructions below

Step 1: Located the USB connectors. The locations of the USB connectors are shown in Chapter 1

Step 2: Align the connectors. Align the USB device connector with one of the connectors on the I/O panel.

Step 3: Insert the device connector. Once aligned, gently insert the USB device connector into the onboard connector.

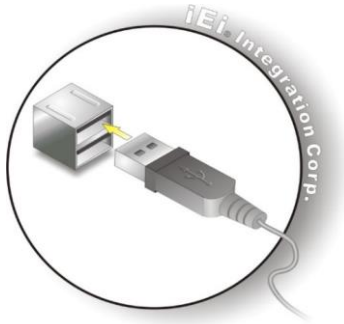

Figure 3-21: USB Connection

3.9 Powering On/Off the System



WARNING:

Make sure a power supply with the correct input voltage is being fed into the system. Incorrect voltages applied to the system may cause damage to the internal electronic components and may also cause injury to the user.

The power of the system needs more than 12-24V 60W.

Step 1: Connect the power source to the power input terminal.

Step 2: Push the power button.

Step 3: Once turned on, the power LED indicator should turn on in orange.

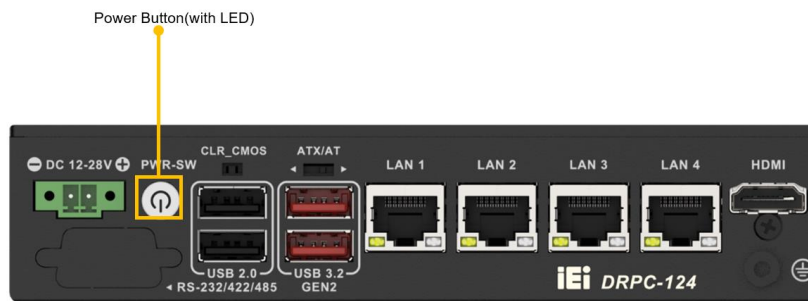

Figure 3-22: Power Input

DRPC-140-EHL

- **Power on** the system: press the power button for 1 seconds
- **Power off** the system: press the power button for 6 seconds

3.10 Available Drivers

All the drivers for the DRPC-140-EHL Series are available on IEI Resource Download Center (<https://download.ieiworld.com>). Type DRPC-140-EHL Series and press Enter to find all the relevant software, utilities, and documentation.

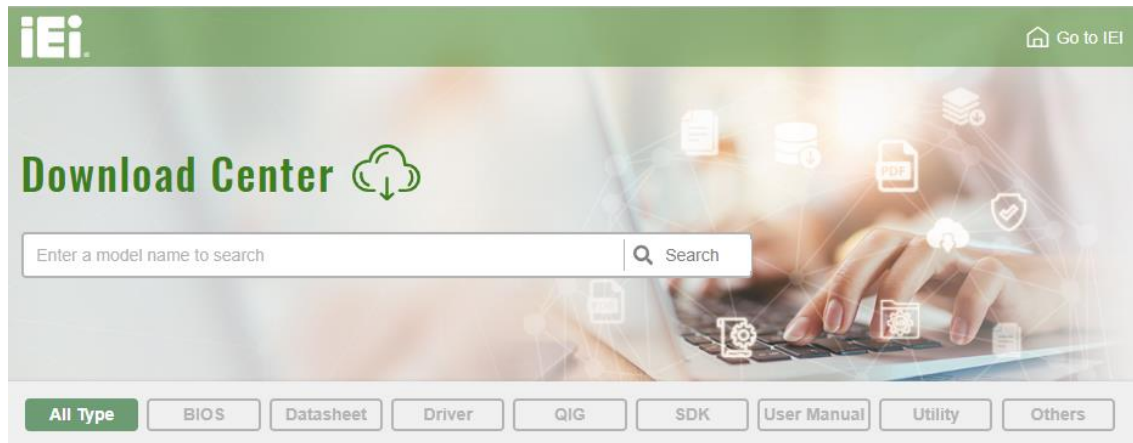

IEI Resource Download Center

3.10.1 Driver Download

To download drivers from IEI Resource Download Center, follow the steps below.

Step 1: Go to <https://download.ieiworld.com>. Type DRPC-140-EHL Series and press Enter.

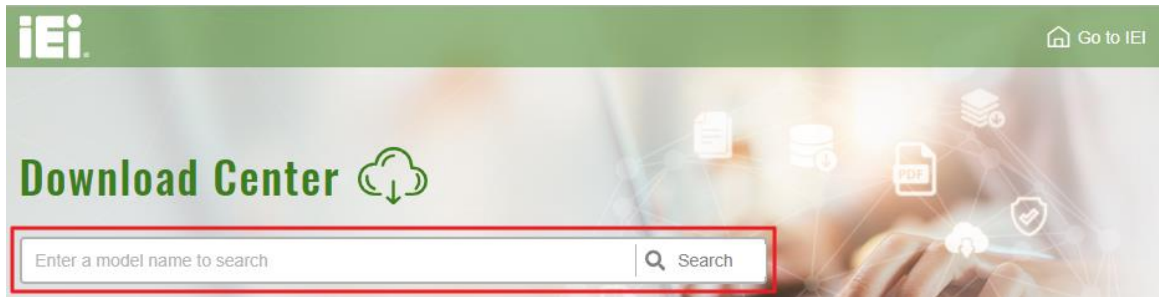

Step 2: All product-related software, utilities, and documentation will be listed. You can choose **Driver** to filter the result.

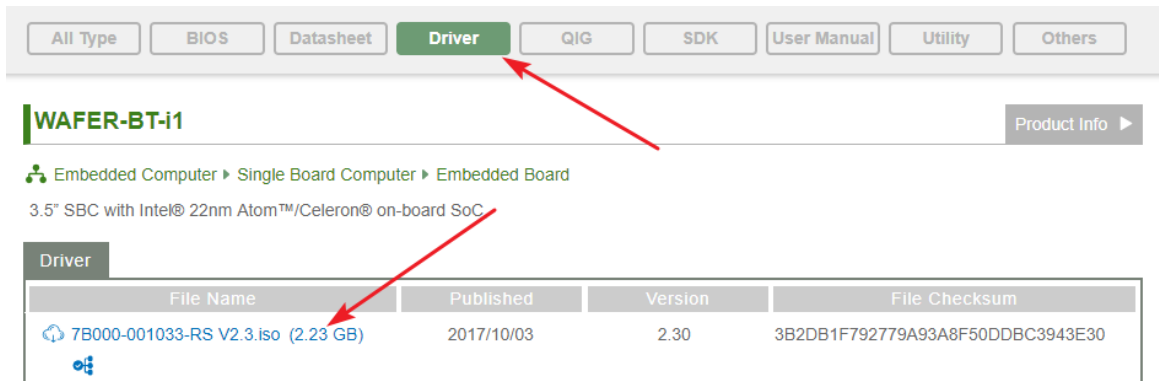

Step 3: Click the driver file name on the page and you will be prompted with the following window. You can download the entire ISO file (❶), or click the small arrow to find an individual driver and click the file name to download (❷).

DRPC-140-EHL

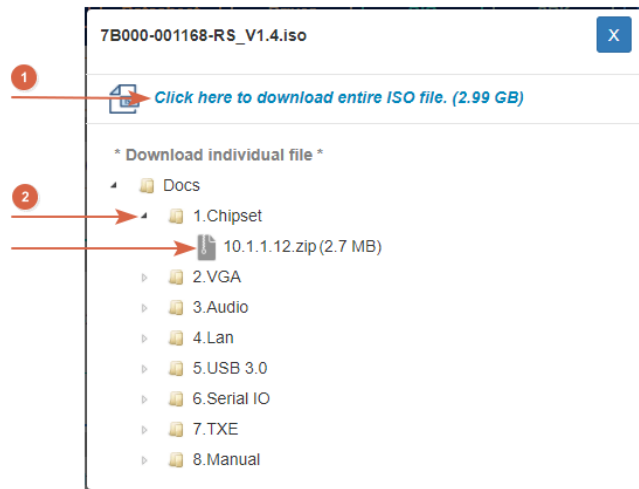

NOTE:

To install software from the downloaded ISO image file in Windows 10 (or later), double-click the ISO file to mount it as a virtual drive to view its content.

Chapter

4

System Motherboard

DRPC-140-EHL

4.1 Layout

The following diagram shows the locations of the internal/external connectors and jumpers on the motherboard.

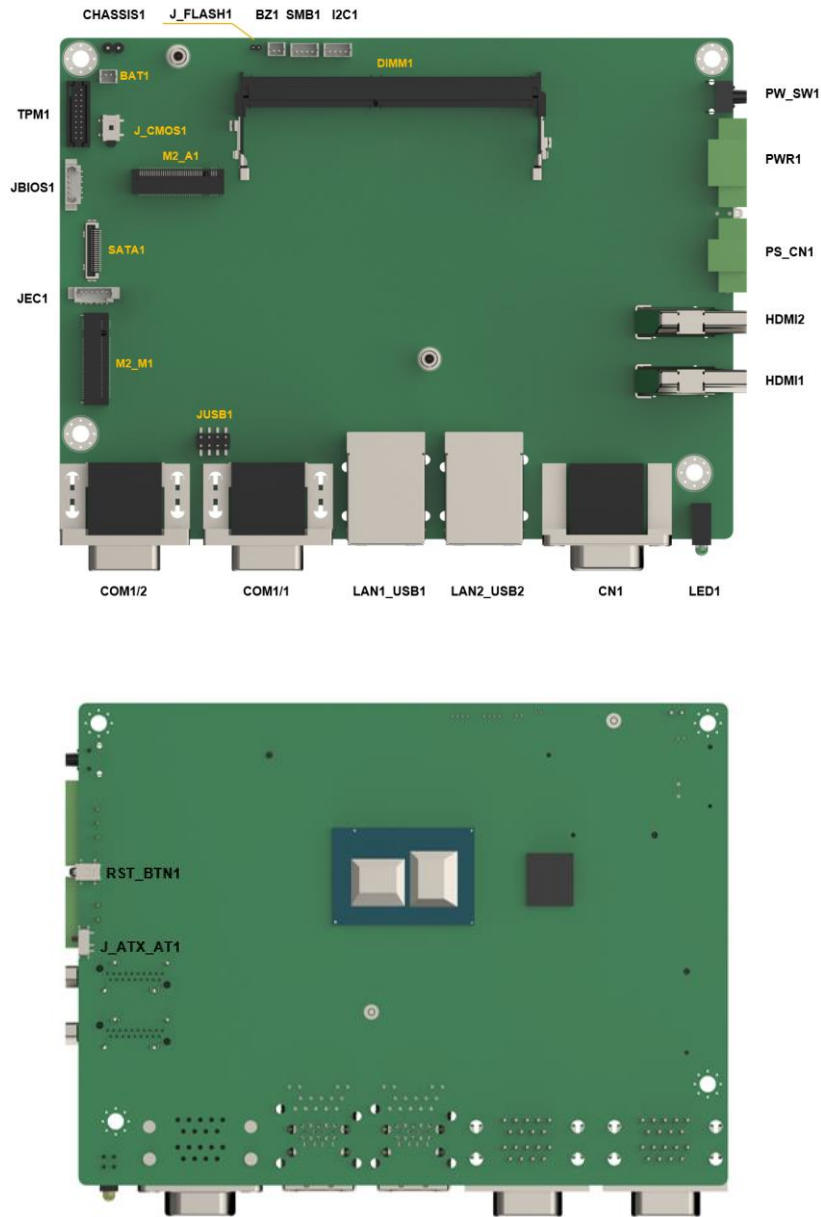

Figure 4-1: Connector and Jumper Locations

4.2 Peripheral Interface Connectors

The table below lists all the external connectors.

Connector	Type	Label
Reset button	Button	RST_BTN1
AT/ATX power mode setting	Switch	J_ATX_AT1
DIO connector	DB9 male	CN1
CAN BUS connector	DB9 female	CN1
LAN+USB connector	RJ45+USB 3.1 GEN2	LAN1_USB1, LAN2_USB2
RS-232/422/485 serial port connectors	DB9 male	COM1/1, COM1/2
Power switch	2-pin switch	PS_CN1
DC power in (12-24V input)	3-pin terminal	PWR1
PWR button	2-pin TACT switch	PWR_SW1
HDMI connector	19-pin female	HDMI1, HDMI2

Table 4-1: Peripheral Interface Connectors

DRPC-140-EHL

4.2.1 AT/ATX Power Mode Setting

- CN Label:** J_ATX_AT1
- CN Type:** 3-pin switch
- CN Location:** See **Figure 4-2**
- CN Pinouts:** See **Table 4-2**

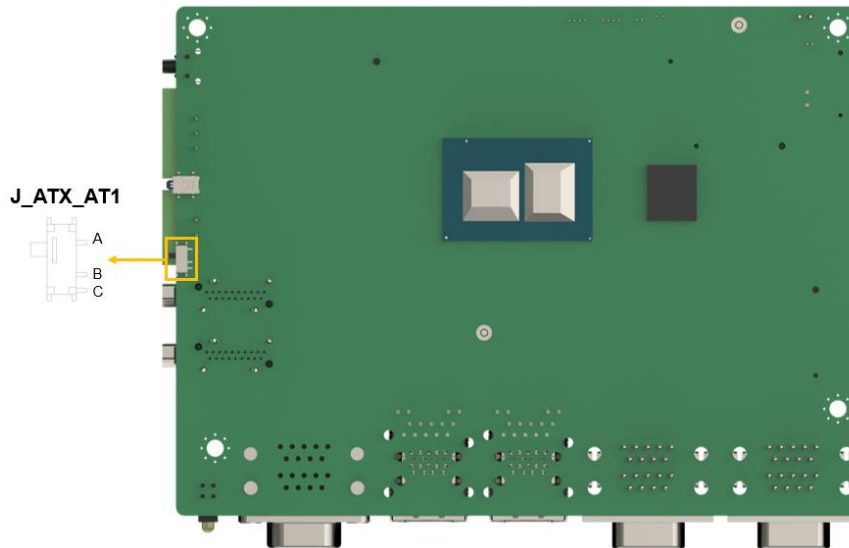

Figure 4-2: AT/ATX Power Mode Switch Locations

PIN NO.	DESCRIPTION
Short A - B	ATX Power Mode (default)
Short B - C	AT Power Mode

Table 4-2: AT/ATX Power Mode Switch Pinouts

4.2.2 Reset Button Mode Setting

- CN Label:** RST_BTN1
- CN Type:** Electronic Switch
- CN Location:** See **Figure 4-3**
- CN Pinouts:** See **Table 4-3**

The Reset Button is commonly used in electronic devices and computers to solve problems with the device or system and reset it to default or factory settings.

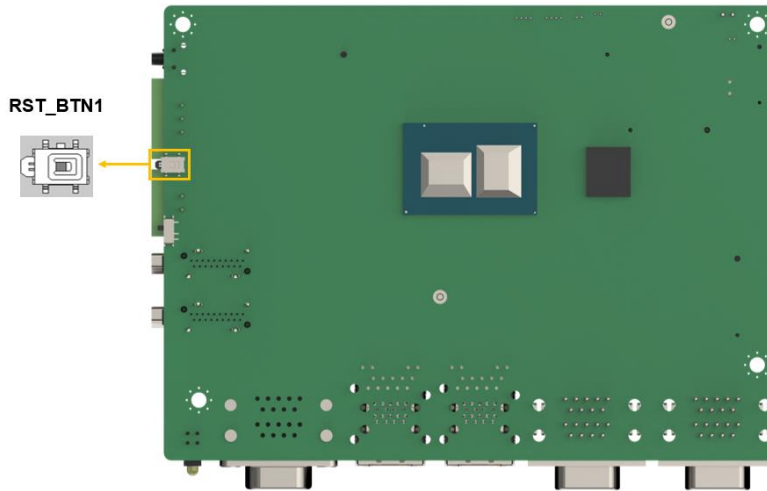

Figure 4-3: Reset Button Connector Location

PIN NO.	DESCRIPTION
NC (default)	
Press button	Reset Button

Table 4-3: Reset Button Connector Pinouts

4.2.3 DIO and CAN Bus Connector

- CN Label:** CN1
- CN Type:** D-SUB 9F+9M DUBLE connector
- CN Location:** See **Figure 1-2**
- CN Pinouts:** See **Table 4-4&Table 4-5**

The digital I/O connector provides programmable input and output for external devices. The digital I/O provides 4-bit output and 4-bit input. The pinouts of the D-sub 9 male connector are listed below (**Table 4-4**).

The DRPC-140-EHL Series has one CAN bus connector that supports two CAN bus connections. The pinouts for the CAN bus connector are listed in the table below (**Table 4-5**).

DRPC-140-EHL

Pin	Description	Pin	Description
1	DIN0	6	DOUT2
2	DOUT0	7	DIN3
3	DIN1	8	DOUT3
4	DOUT1	9	+V5
5	DIN2		

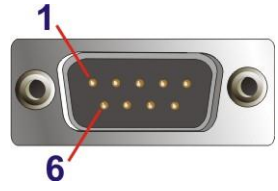

Table 4-4: Digital IO Connector Pinouts

Pin	Description	Pin	Description
1	CAN0_GND	6	CAN0_L
2	CAN0_H	7	N/C
3	N/C	8	N/C
4	CAN1_GND	9	CAN1_L
5	CAN1_H		

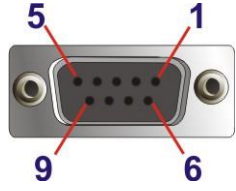

Table 4-5: CAN Bus Connector Pinouts

4.3 Internal Interface Connectors

The table below lists the connectors on the board

Connector	Type	Label
Clear CMOS button	Button	J_CMOS1
Battery connector	2-pin wafer	BAT1
Case open connector	2-pin wafer	CHASSIS1
Flash descriptor override setting jumper	3-pin header	J_FLASH1
DDR4 Memory SO DIMM CONN	260-pin socket	DIMM1
I2C connector	4-pin wafer	I2C1
SMBUS(2.0) Connector	4-pin wafer	SMB1

Buzzer Connector	2-pin wafer	BZ1
M.2 A-key slot	M.2 A-key slot	M2_A1
M.2 M-key slot	M.2 M-key slot	M2_M1
Internal USB 2.0 connector	8-pin header	J_USB1
EC debug port connector	6-pin header	J_EC1
SATA 6Gb/s connector	20-pin SATA connector	SATA1
Flash SPI ROM connector	6-pin wafer	JBIOS1
SPI TPM Connector	20-pin header	TPM1

Table 4-6: Internal interface Connectors

4.3.1 Clear CMOS Button Connector

CN Label: J_CMOS1

CN Type: Button

CN Location: See **Figure 4-4**

CN Pinouts: See **Table 4-7**

To clear the CMOS Setup (for example if you have forgotten the password, you should clear the CMOS and then reset the password), you should disconnect the RTC battery and press the button for about 3 seconds. This will set back to normal operation mode.

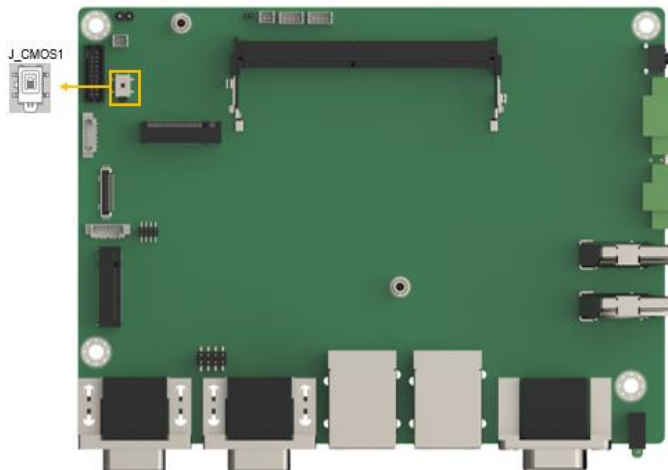

Figure 4-4: Clear CMOS Location

DRPC-140-EHL

PIN NO.	DESCRIPTION
NC (default)	Keep CMOS Setup (Normal Operation)
Press button	Clear CMOS Setup

Table 4-7: Clear CMOS Pinouts

4.3.2 Case Open Circuit Setting

- CN Label:** CHASSIS1
- CN Type:** 2-pin header, P=2.54 mm
- CN Location:** See **Figure 4-5**
- CN Pinouts:** See **Table 4-8**

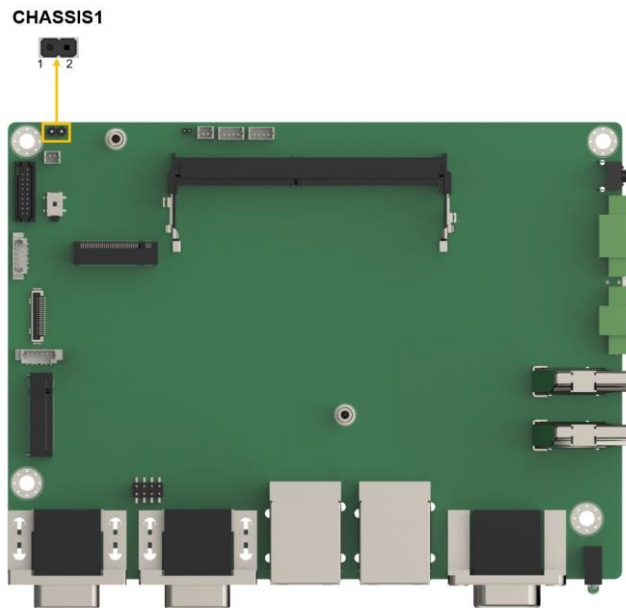

Figure 4-5: Case Open Circuit Setting Locations

PIN NO.	DESCRIPTION
Open	Chassis close
Short	Chassis open

Table 4-8: Case Open Circuit Setting Pinouts

4.3.3 Flash Descriptor Override Setting Jumper

- CN Label:** J_FLASH1
- CN Type:** 2-pin header, P=1.27mm
- CN Location:** See Figure 4-6
- CN Pinouts:** See Table 4-9

The **J_FLASH1** connector is used for Flash Descriptor Security Override.

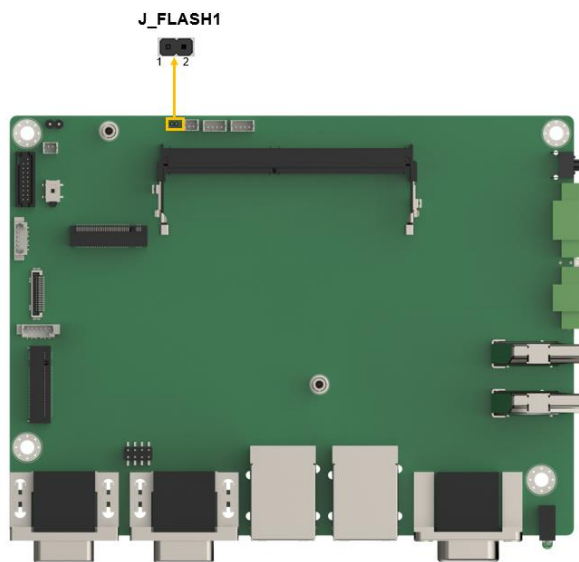

Figure 4-6: Flash Descriptor Override Setting Jumper Locations

PIN NO.	DESCRIPTION
Low	Disable (Default, no override)
High	Enabled(override)

Table 4-9: Flash Descriptor Override Setting Jumper Pinouts

DRPC-140-EHL

To update the ME firmware, please follow the steps below.

- Step 1:** Before turning on the system power, short the Flash Descriptor Security Override jumper.
- Step 2:** Update the BIOS and ME firmware, and then turn off the system power.
- Step 3:** Remove the metal clip on the Flash Descriptor Security Override jumper to its default setting.
- Step 4:** Restart the system. The system will reboot 2 ~ 3 times to complete the ME firmware update.

4.3.4 RTC Battery Connector



CAUTION:

Risk of explosion if battery is replaced by an incorrect type. Only certified engineers should replace the on-board battery.

Dispose of used batteries according to instructions and local regulations.



NOTE:

It is recommended to attach the RTC battery onto the system chassis in which the DRPC-140-EHL Series is installed.

CN Label:	BAT1
CN Type:	2-pin wafer, p=1.25 mm
CN Location:	See Figure 4-7
CN Pinouts:	See Table 4-10

The battery connector is connected to the system battery. The battery provides power to the system clock to retain the time when power is turned off.

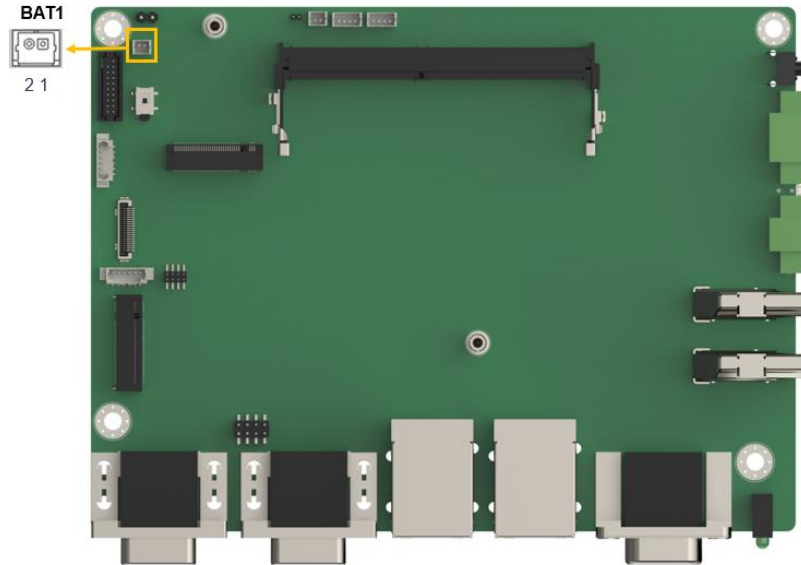

Figure 4-7: Battery Connector Location

Pin	Description
1	VBATT
2	GND

Table 4-10: Battery Connector Pinouts

4.3.5 Buzzer Connector

- CN Label:** BZ1
- CN Type:** 2-pin wafer, p=1.25 mm
- CN Location:** See **Figure 4-8**
- CN Pinouts:** See **Table 4-11**

The buzzer connector is connected with the buzzer to give a beep warning when the motherboard goes wrong.

DRPC-140-EHL

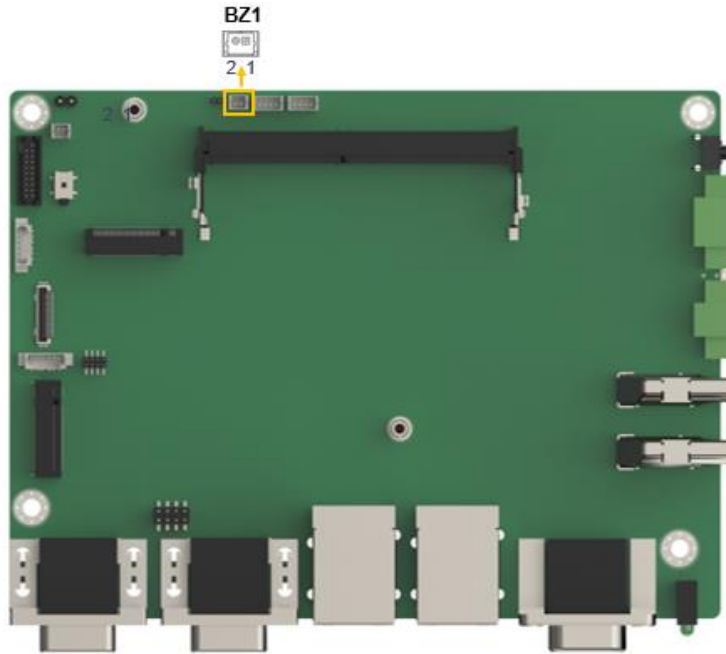

Figure 4-8: Buzzer Connector Location

Pin	Description
1	+5V
2	PC_BEEP

Table 4-11: Buzzer Connector Pinouts

4.3.6 DDR4 SO-DIMM Socket

- CN Label:** DIMM1
- CN Type:** 260-pin DDR4 SO-DIMM slot
- CN Location:** See **Figure 4-9**

The SO-DIMM slot is for installing the DDR4 SO-DIMM.

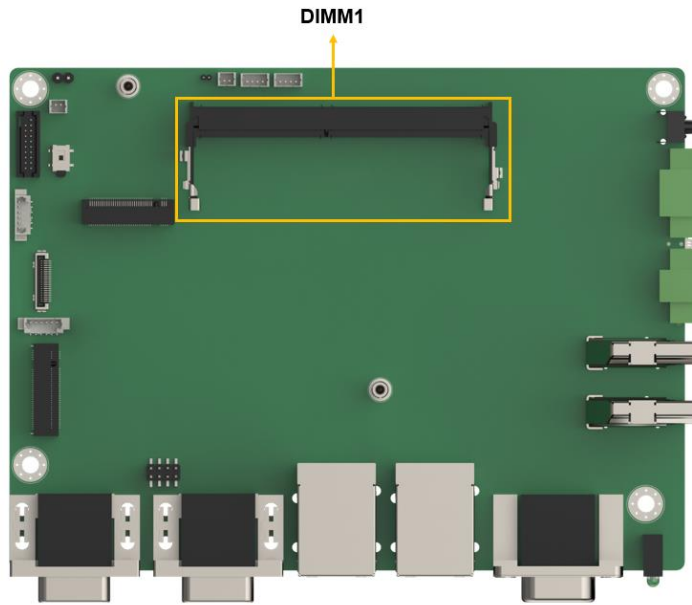

Figure 4-9: DDR4 SO-DIMM Socket Location

DRPC-140-EHL

4.3.7 Mini SATA Connector

- CN Label:** SATA1
- CN Type:** 20-pin Mini SATA connector
- CN Location:** See **Figure 4-10**
- CN Pinouts:** See **Table 4-12**

The SATA 6Gb/s drive connector is connected to a SATA 6Gb/s drive. The SATA 6Gb/s drive transfers data at speeds as high as 6Gb/s.

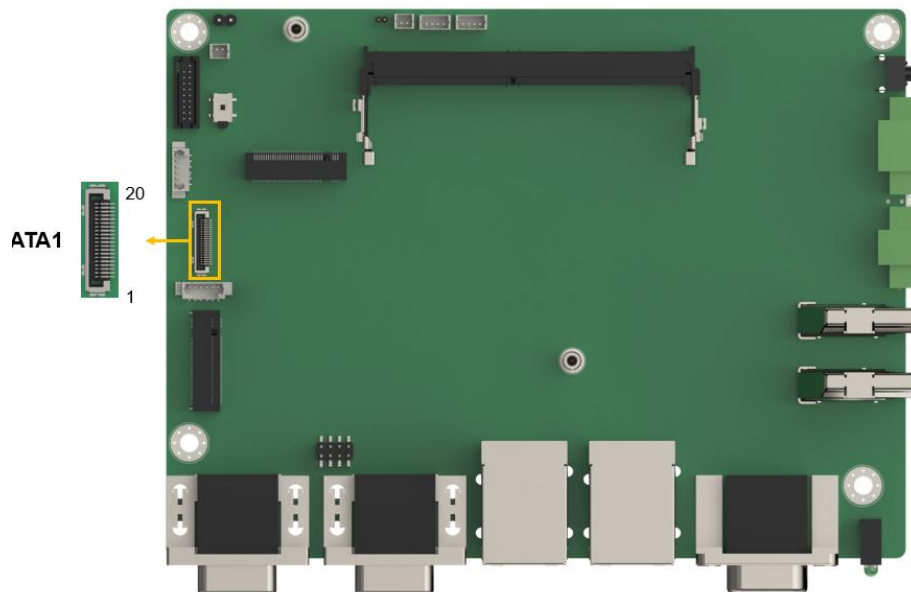

Figure 4-10: Mini SATA Connectors Location

PIN NO.	DESCRIPTION	PIN NO.	DESCRIPTION
1	GND	11	+5VS
2	GND	12	N/C
3	GND	13	N/C
4	GND	14	GND
5	GND	15	SATA_RX+
6	GND	16	SATA_RX-
7	+5VS	17	GND
8	+5VS	18	SATA_TX-
9	+5VS	19	SATA_TX+

10	+5VS	20	GND
----	------	----	-----

Table 4-12: SATA 6Gb/s Drive Connectors Pinouts

4.3.8 SPI TPM Connector

- CN Label:** TPM1
- CN Type:** 20-pin header
- CN Location:** See **Figure 4-11**
- CN Pinouts:** See **Table 4-14**

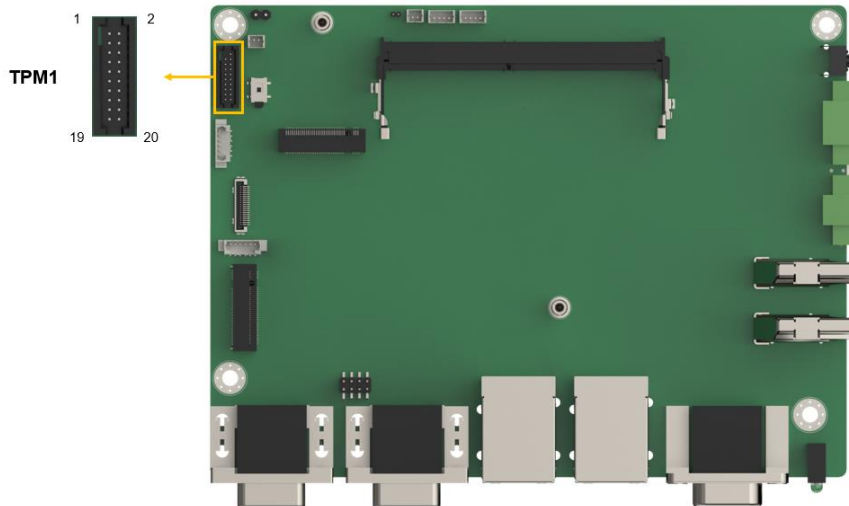

Figure 4-11: SPI TPM Connectors Location

PIN NO.	DESCRIPTION	PIN NO.	DESCRIPTION
1	N/A	2	TPM_SPI_CS0_N
3	+V3.3	4	TPM_SPI_CS1_N
5	GND	6	+V3.3
7	SPI_CLK_TPM	8	SPI_TPM_DQ2
9	TPM_SPI_DQ3	10	TPM_SPI_MISO
11	SPI_TPM_HOLD_R_N	12	TPM_SPI_MOSI
13	SPI_TPM_CS2_R	14	GND
15	TPM_WP#	16	N/A
17	SPI_TPM_INT_N	18	+V3.3

DRPC-140-EHL

PIN NO.	DESCRIPTION	PIN NO.	DESCRIPTION
19	PLT_RST_N	20	+V3.3

Table 4-13: SPI TPM Connector (TPM1) Pinouts

4.3.9 Flash SPI ROM Connector

- CN Label:** JBIOS1
- CN Type:** 6-pin wafer, p=1.25 mm
- CN Location:** See **Figure 4-12**
- CN Pinouts:** See **Table 4-14**

The 6-pin Flash SPI ROM connector is used to flash the BIOS.

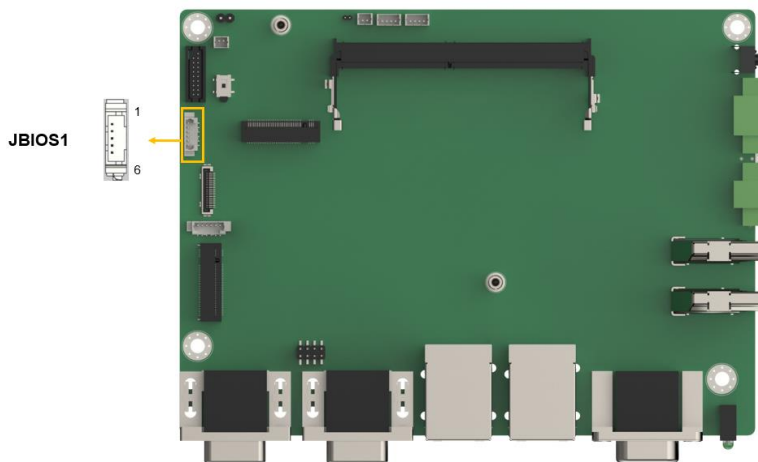

Figure 4-12: Flash SPI ROM Connector Location

Pin	Description
1	+3.3V
2	SPI_CS#
3	SPI_SO
4	SPI_CLK
5	SPI_SI
6	GND

Table 4-14: Flash SPI ROM Connector Pinouts

4.3.10 I²C Connector

- CN Label:** I2C1
- CN Type:** 4-pin wafer, p=1.25 mm
- CN Location:** See **Figure 4-13**
- CN Pinouts:** See **Table 4-15**

The SMBus (System Management Bus) connector provides low-speed system management communications.

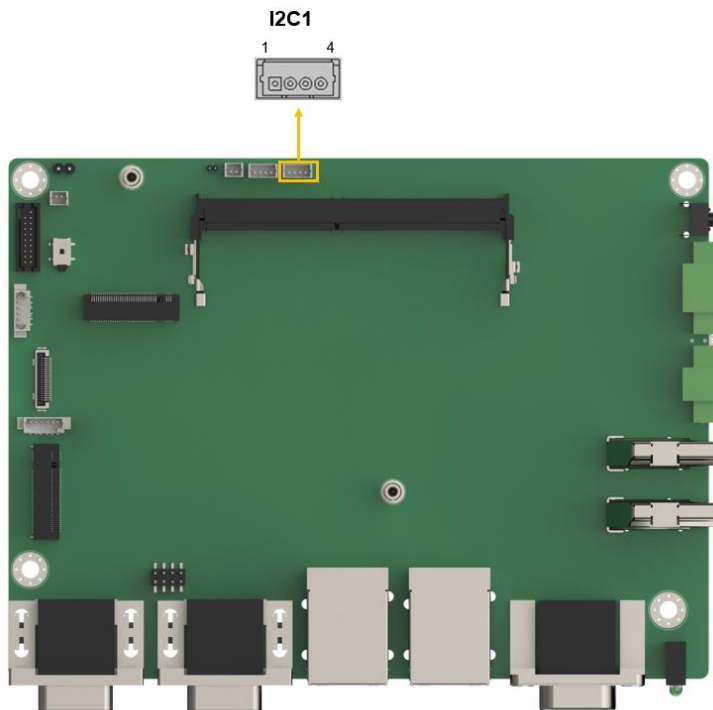

Figure 4-13: I²C Connector Location

Pin	Description
1	GND
2	I2C_DATA
3	I2C_CLK
4	+5V

Table 4-15: I²C Connector Pinouts

DRPC-140-EHL

4.3.11 EC ROM Debug Connector

- CN Label:** JEC1
- CN Type:** 6-pin wafer, p=1.25 mm
- CN Location:** See **Figure 4-14**
- CN Pinouts:** See **Table 4-16**

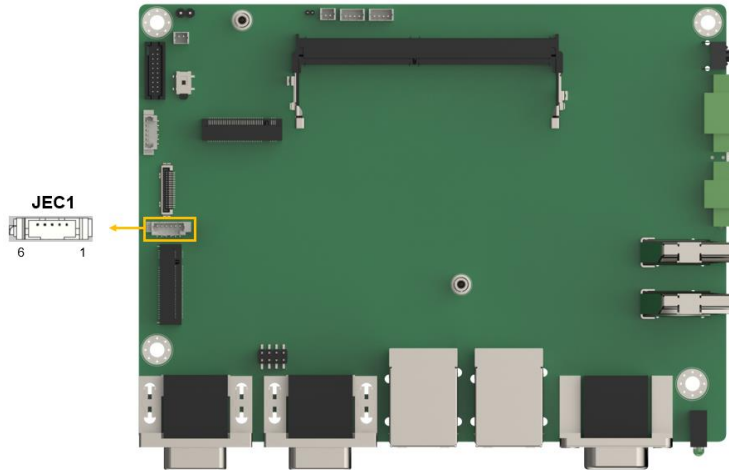

Figure 4-14: EC ROM Debug Connector Location

Pin	Description	Pin	Description
1	EDICS	4	G2
2	G1	5	EDICLK
3	EDIDO	6	EDIDI

Table 4-16: EC ROM Debug Connector Pinouts

4.3.12 Internal USB 2.0 Connectors

- CN Label:** JUSB1
- CN Type:** 8-pin header, p=2.00 mm
- CN Location:** See **Figure 4-15**
- CN Pinouts:** See **Table 4-17**

The USB connector provides USB 2.0 ports by dual-port USB cable.

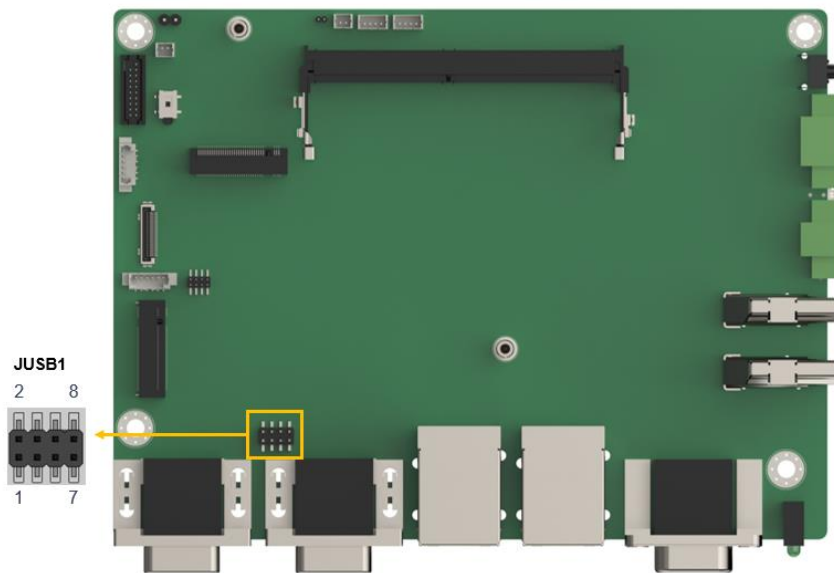

Figure 4-15: Internal USB 2.0 Connectors Locations

PIN NO.	DESCRIPTION	PIN NO.	DESCRIPTION
1	VCC	2	GND
3	USB DATA-	4	USB DATA+
5	USB DATA+	6	USB DATA-
7	GND	8	VCC

Table 4-17: Internal USB 2.0 Connectors Pinouts

DRPC-140-EHL

4.3.13 SMBUS (2.0) Connector

- CN Label:** SMB1
- CN Type:** 4-pin wafer, p=1.25 mm
- CN Location:** See **Figure 4-16**
- CN Pinouts:** See **Table 4-19**

The SMBus is a two-wire bus used for communication with low bandwidth devices on a motherboard such as power related chips and temperature sensors.

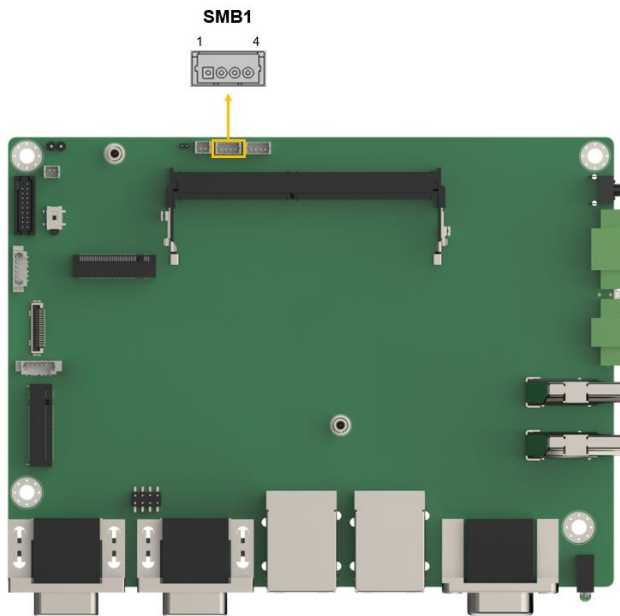

Figure 4-16: SMBUS (2.0) Connector Location

Pin	Description
1	GND
2	SMB_DATA
3	SMB_CLK
4	+5V

Table 4-18: SMBUS (2.0) Connector Pinouts

4.3.14 M.2 A-key Slot

- CN Label:** M2_A1
- CN Type:** M.2 A-key slot
- CN Location:** See **Figure 4-17**
- CN Pinouts:** See **Table 4-19**

The M.2 slot is keyed in the A position and accepts 2230 size of M.2 modules. The M.2 slot supports PCIe Gen3 x1 and USB 2.0 signals.

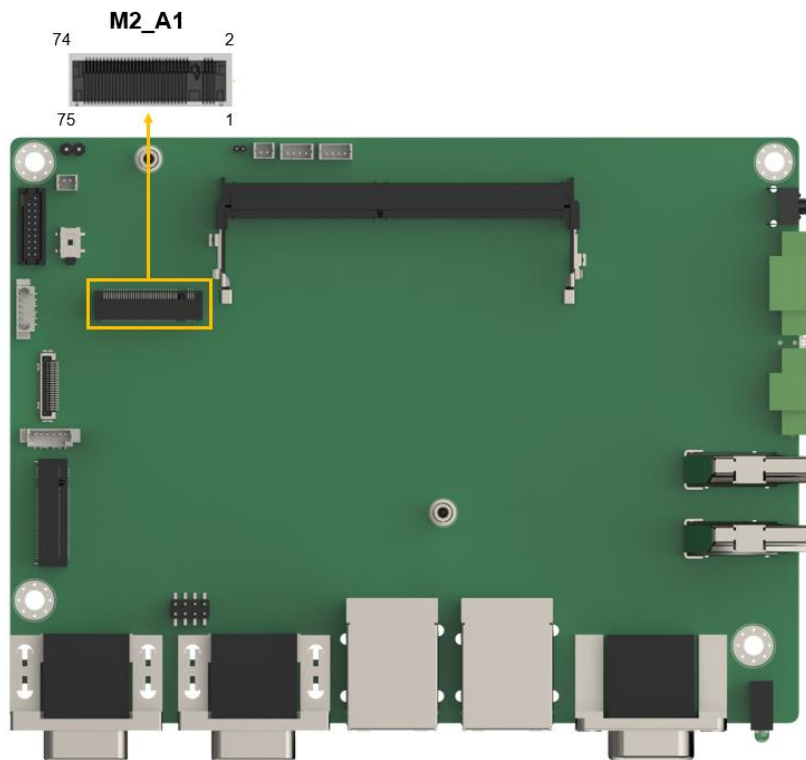

Figure 4-17: M.2 A-key Slot Location

Pin	Description	Pin	Description
1	GND	2	+V3.3A
3	USB+	4	+V3.3A
5	USB-	6	NC
7	GND	8	Module Key

DRPC-140-EHL

Pin	Description	Pin	Description
9	Module Key	10	Module Key
11	Module Key	12	Module Key
13	Module Key	14	Module Key
15	Module Key	16	NC
17	NC	18	GND
19	NC	20	NC
21	NC	22	NC
23	GND	24	GND
25	NC	26	NC
27	NC	28	NC
29	GND	30	GND
31	NC	32	NC
33	GND	34	NC
35	PCIE_TX2+	36	GND
37	PCIE_TX2-	38	NC
39	GND	40	NC
41	PCIE_RX2+	42	NC
43	PCIE_RX2-	44	NC
45	GND	46	NC
47	CLK_PCIE2+	48	NC
49	CLK_PCIE2-	50	PMC_SUS_CLK
51	GND	52	WLAN_PERST#
53	NC	54	+V3.3A_WLAN
55	+V3.3A_WLAN	56	+V3.3A_WLAN
57	GND	58	NC
59	NC	60	NC
61	NC	62	NC
63	GND	64	NC
65	NC	66	NC
67	NC	68	NC
69	GND	70	NC
71	NC	72	+V3.3A
73	NC	74	+V3.3A

Pin	Description	Pin	Description
75	GND		

Table 4-19: M.2 A-Key Slot Pinouts

4.3.15 M.2 M-key Slot

- CN Label:** M2_M1
- CN Type:** M.2 M-key slot
- CN Location:** See **Figure 4-18**
- CN Pinouts:** See **Table 4-20**

The M.2 M key (2280) slot with PCIe Gen3 x2 supports NVMe storage.

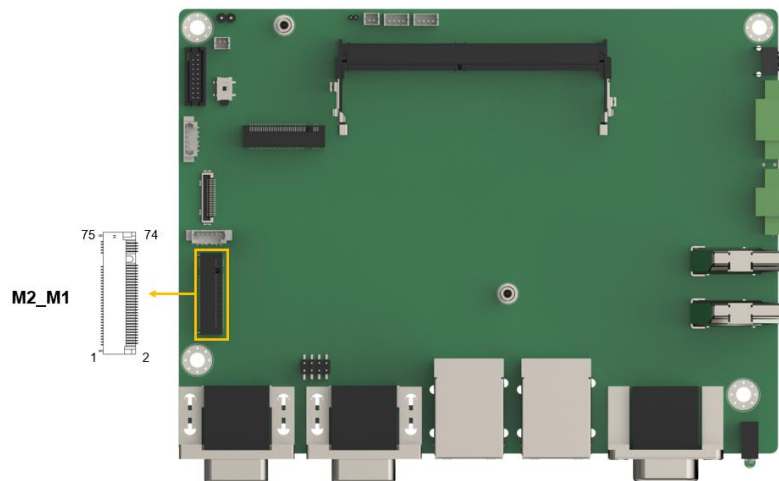

Figure 4-18: M.2 M-key Slot Location

PIN NO.	DESCRIPTION	PIN NO.	DESCRIPTION
1	GND	2	+3.3V
3	GND	4	+3.3V
5	N/C	6	N/C
7	N/C	8	N/C
9	GND	10	DAS/DSS#
11	N/C	12	+3.3V
13	N/C	14	+3.3V
15	GND	16	+3.3V

DRPC-140-EHL

17	N/C	18	+3.3V
19	N/C	20	N/C
21	GND	22	N/C
23	N/C	24	N/C
25	N/C	26	N/C
27	GND	28	N/C
29	PCIE_RXN1	30	N/C
31	PCIE_RXP1	32	N/C
33	GND	34	N/C
35	PCIE_TXN1	36	N/C
37	PCIE_TXP1	38	DEVSLP
39	GND	40	N/C
41	PCIE_RXN0	42	N/C
43	PCIE_RXP0	44	N/C
45	GND	46	N/C
47	PCIE_TXN0	48	N/C
49	PCIE_TXP0	50	PERST#
51	GND	52	CLKREQ#
53	REFCLKN	54	PEWAKE
55	REFCLKP	56	N/C
57	GND	58	N/C
59	Module Key	60	Module Key
61	Module Key	62	Module Key
63	Module Key	64	Module Key
65	Module Key	66	Module Key
67	N/C	68	SUSCLK
69	PEDET	70	+3.3V
71	GND	72	+3.3V
73	GND	74	+3.3V
75	GND		

Table 4-20: M.2 M-key Slot Pinouts

Chapter

5

BIOS

5.1 Introduction

The BIOS is programmed onto the BIOS chip. The BIOS setup program allows changes to certain system settings. This chapter outlines the options that can be changed.



NOTE:

Some of the BIOS options may vary throughout the life cycle of the product and are subject to change without prior notice.

5.1.1 Starting Setup

The UEFI BIOS is activated when the computer is turned on. The setup program can be activated in one of two ways.

1. **Using keyboard:** Press the **DEL** or **F2** as soon as the system is turned on.
2. **Using touchscreen:** Press the **Setup** button on the upper right corner of the BIOS Starting Menu.

If the message disappears before the **DEL** or **F2** key is pressed, restart the computer and try again, then the BIOS Starting Menu will appear. Select "Setup" and press Enter to get into the BIOS Setup.

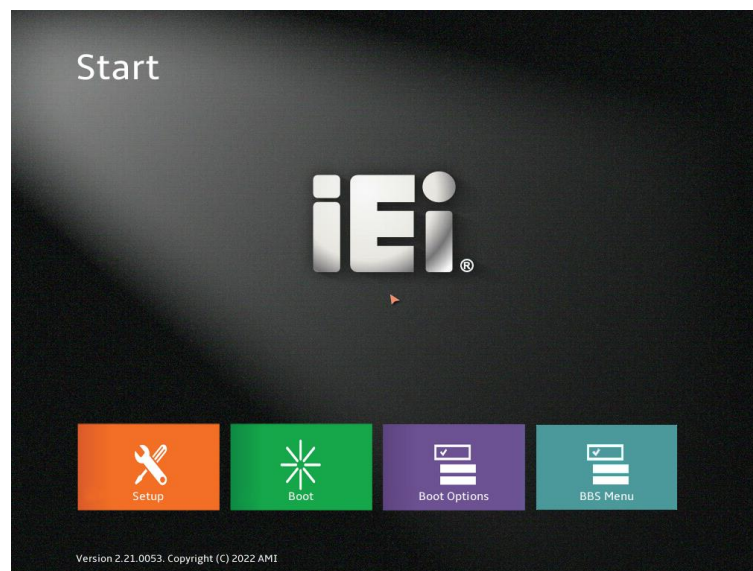

Figure 5-1: BIOS Starting Menu

5.1.2 Using Setup

The BIOS Setup menu can be navigated by using a keyboard or a touchscreen.

5.1.2.1 Keyboard Navigation

For keyboard navigation, use the navigation keys shown in **(Figure 5-2)**.

Key	Function
Up arrow	Move to previous item
Down arrow	Move to next item
Left arrow	Move to the item on the left hand side
Right arrow	Move to the item on the right hand side
+	Increase the numeric value or make changes
-	Decrease the numeric value or make changes
Page Up	Move to the previous page
Page Dn	Move to the next page
Esc	Main Menu – Quit and not save changes into CMOS Status Page Setup Menu and Option Page Setup Menu -- Exit current page and return to Main Menu
F1	General help, only for Status Page Setup Menu and Option Page Setup Menu
F2	Load previous values
F3	Load optimized defaults
F4	Save changes and Exit BIOS
<K>	Scroll help area upwards
<M>	Scroll help area downwards

Figure 5-2: BIOS Navigation Keys

5.1.2.2 Touch Navigation

For touchscreen navigation, use the on-screen navigation keys shown below (Figure 5-3).



On-screen Button	Function
Previous Values	Load the last value you set.
Optimized Defaults	Load the factory default values in order to achieve the best performance.
Back	Return to the previous menu.
Soft kbd	Display the on-screen keyboard.
Save & Exit	Save the changes made to the BIOS options and reset the system.

Figure 5-3: BIOS On-screen Navigation Keys

5.1.3 Getting Help

When **F1** is pressed a small help window describing the appropriate keys to use and the possible selections for the highlighted item appears. To exit the Help Window, press the **Esc** key.

5.1.4 Unable to Reboot after Configuration Changes

If the computer cannot boot after changes to the system configuration is made, CMOS defaults. Use the clear CMOS button described in **Chapter 4**.

5.1.5 BIOS Menu Bar

The **menu bar** on top of the BIOS screen has the following main items:

- Main – Changes the basic system configuration.
- Advanced – Changes the advanced system settings.
- Chipset – Changes the chipset settings.
- Security – Sets User and Supervisor Passwords.
- Boot – Changes the system boot configuration.
- Save & Exit – Selects exit options and loads default settings

The following sections completely describe the configuration options found in the menu items at the top of the BIOS screen and listed above.

DRPC-140-EHL

5.2 Main

The **Main** BIOS menu (**BIOS Menu 1 & BIOS Menu 2**) appears when the **BIOS Setup** program is entered. The **Main** menu gives an overview of the basic system information.



BIOS Menu 1: Main (1/2)

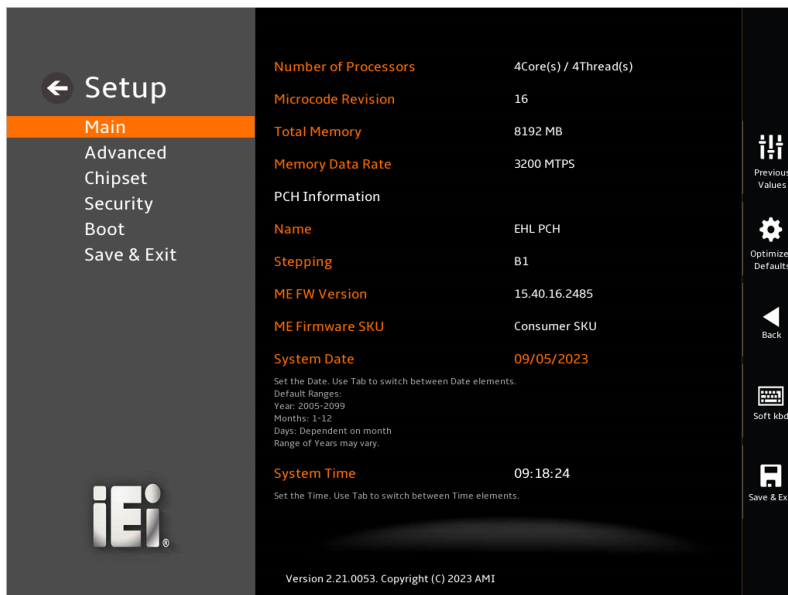

BIOS Menu 2: Main (2/2)

→ BIOS Information

The **BIOS Information** lists a brief summary of the BIOS. The fields in **BIOS Information** cannot be changed. The items shown in the system overview include:

- **BIOS Vendor:** Installed BIOS vendor
- **Core Version:** Current BIOS version
- **Compliance:** Current UEFI & PI version
- **Project Version:** the board version
- **Build Date and Time:** Date the current BIOS version was made
- **Access Level:** Administrator
- **EC Version:** Current EC version

→ Compute Die Information

The **Processor Information** lists a brief summary of the Processor. The fields in **Processor Information** cannot be changed. The items shown in the system overview include:

- **Name:** Displays the Processor Details
- **Type:** Displays the Processor Type
- **Speed:** Displays the Processor Speed
- **ID:** Displays the Processor ID
- **Stepping:** Displays the Processor Stepping
- **Package:** Displays the Processor Package
- **Number of Processors:** Displays number of CPU cores
- **Microcode Revision:** CPU Microcode Revision
- **GT Info:** Processor GT info. Only valid if SNB stepping is D0 or above
- **IGFX GOP Version:** Displays the IGFX GOP Version
- **Total Memory:** Total Memory in the System
- **Memory Data Rate:** Displays the Rate of Memory Data

→ PCH Information

The **PCH Information** lists a brief summary of the PCH. The fields in **PCH Information** cannot be changed. The items shown in the system overview include:

- **Name:** Displays the PCH Name

DRPC-140-EHL

- **PCH SKU:** Displays the PCH SKU
- **Stepping:** Displays the PCH Stepping
- **ME FW Version:** Displays the ME Firmware Version
- **ME Firmware SKU:** Displays the ME Firmware SKU
- **PMC FW Version:** Displays the PMC Firmware Version

The System Overview field also has two user configurable fields:

→ **System Date [xx:xx:xx]**

Use the **System Date** option to set the system date. Manually enter the day, month and year.

→ **System Time [xx:xx:xx]**

Use the **System Time** option to set the system time. Manually enter the hours, minutes and seconds.

5.3 Advanced

Use the **Advanced** menu (**BIOS Menu 3**) to configure the CPU and peripheral devices through the following sub-menus



WARNING!

Setting the wrong values in the sections below may cause the system to malfunction. Make sure that the settings made are compatible with the hardware.

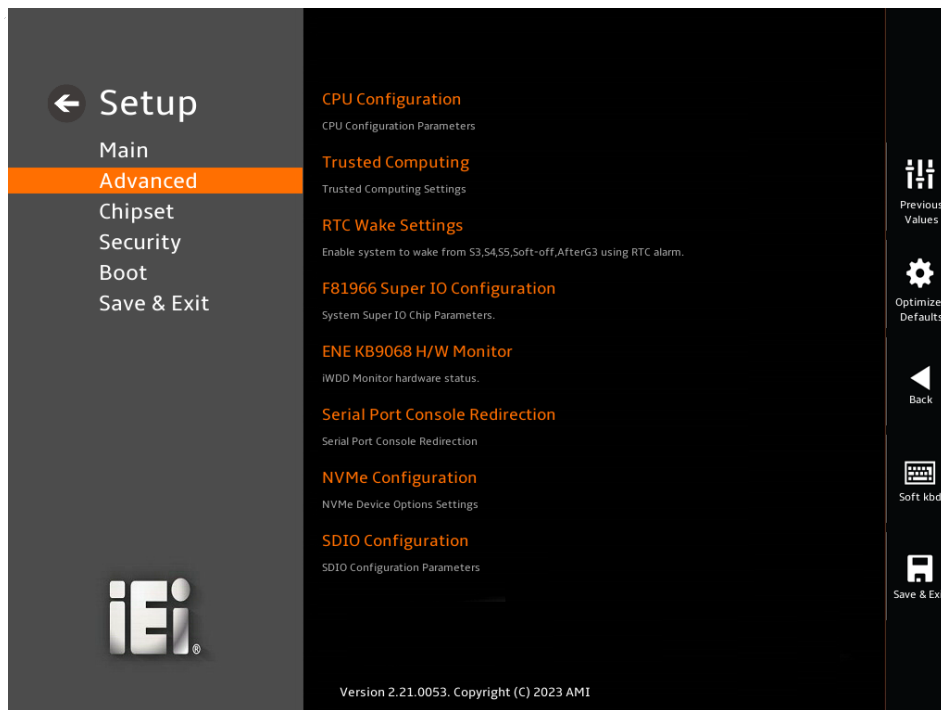

BIOS Menu 3: Advanced

DRPC-140-EHL

5.3.1 CPU Configuration

Use the **CPU Configuration** menu (**BIOS Menu 4 & BIOS Menu 5 & BIOS Menu 6**) to view detailed CPU specifications or enable the Intel Virtualization Technology.



BIOS Menu 4: CPU Configuration (1/3)



BIOS Menu 5: CPU Configuration (2/3)

DRPC-140-EHL**→ EIST [Enabled]**

Use the **EIST** option to enable more than two frequency ranges to be supported.

- Disabled** Disables more than two frequency ranges
- Enabled** **DEFAULT** Enables more than two frequency ranges

→ C states [Disabled]

Use the **C states** option to enable or disable the CPU Power Management.

- Disabled** **DEFAULT** Disables CPU to go to C states when it's not 100% utilized.
- Enabled** Enables CPU to go to C states when it's not 100% utilized.

→ Tcc Activation Offset [0]

Use the **Tcc Activation Offset** option to set Tcc activation temperature at which the Thermal Control Circuit must be activated. Tcc will be activated at: Tcc Activation Temp-Tcc Activation Offset. Tcc Activation Offset range is 0 to 63.

→ Power Limit 1

Use the Power Limit 1 to set Power Limit in Milli Watts. BIOS will round to the nearest 1/8W when programming. 0 = no custom override. For 12.50W, enter 12500. Overclocking SKU: Value must be between Max and Min Power Limits. Other SKUs: This value must be between Min Power limit and TDP Limit. If value is 0, BIOS will program TDP value.

→ Power Limit 1 Time Window

Power Limit 1 Time Window value in second. The value may vary from 0 to 128.0, 0 = default value (28 sec for mobile and 8 sec for desktop). Defines time window which TDP value should be maintained.

→ Power Limit 2

Use the Power Limit 2 to set Power Limit in Milli Watts. BIOS will round to the nearest 1/8W when programming. If the value is 0, BIOS will program this value as 1.25*TDP. For 12.50W, enter 12500. Processor applies control policies such that the package power does not exceed this limit.

→ **Turbo Mode [Enabled]**

Use the **Turbo Mode** option to enable or disable Turbo Mode which requires Intel Speed Step or Intel Speed Shift to be available and enabled.

- **Disabled** Disables Turbo Mode Technology
- **Enabled** **DEFAULT** Enables Turbo Mode Technology

5.3.2 Trusted Computing

The **Trusted Computing** menu (**BIOS Menu 7**) to configure settings related to the Trusted Computing Group (TCG) Trusted Platform Module (TPM).



BIOS Menu 7: Trusted Computing

→ TPM Support [Enable]

Use the **TPM Support** option to configure support for the TPM.

- **Disable** TPM support is disabled.
- **Enable** **DEFAULT** TPM support is enabled.

→ Pending Operation [None]

Use the **Pending Operation** option to schedule an operation for the security device.

- **None** **DEFAULT** TPM information is previous.
- **TPM Clear** TPM information is cleared

5.3.3 RTC Wake settings

The **RTC Wake Settings** menu (**BIOS Menu 8**) to enable system to wake from S3, S4,S5,Soft-off,AfterG3 using RTC alarm.

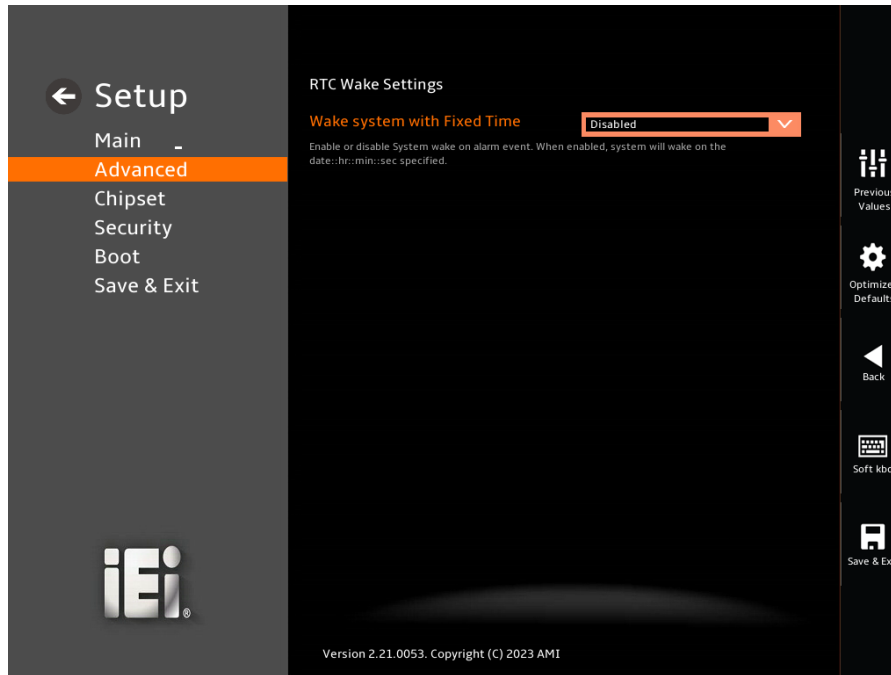

BIOS Menu 8: RTC Wake Settings

- **Wake system with Fixed Time [Disabled]**
 - **Disabled** **DEFAULT** System wake on alarm event disabled.
 - **Enabled** System will wake on the date::hr::min::sec specified

DRPC-140-EHL

5.3.4 F81966 Super IO Configuration

Use the **F81966 Super IO Configuration** menu (**BIOS Menu 9**) to set or change the configurations for the serial ports.

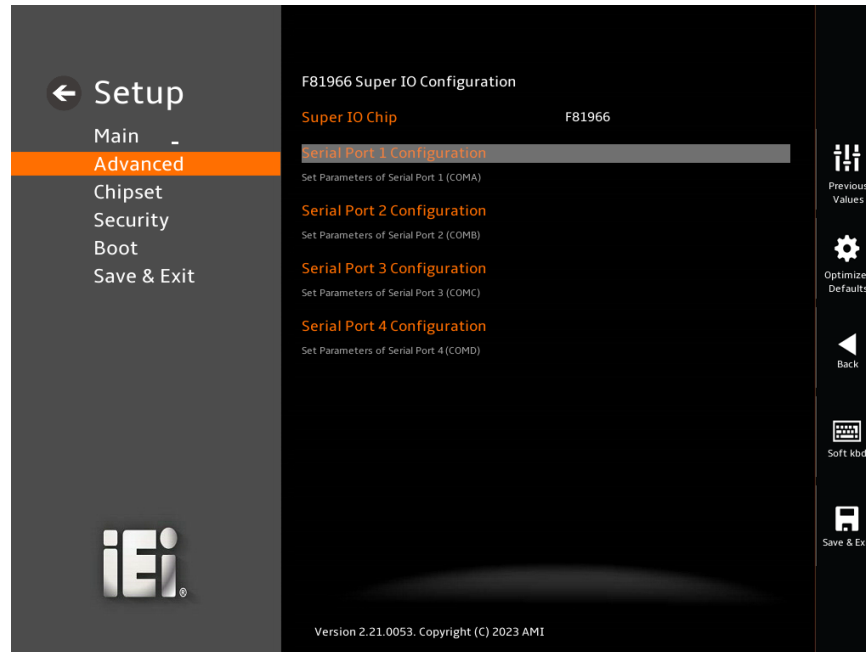

BIOS Menu 9: IT5571 Super IO Configuration

5.3.4.1 Serial Port 1 Configuration

Use the **Serial Port 1 Configuration** menu (**BIOS Menu 10**) to configure the serial port n.

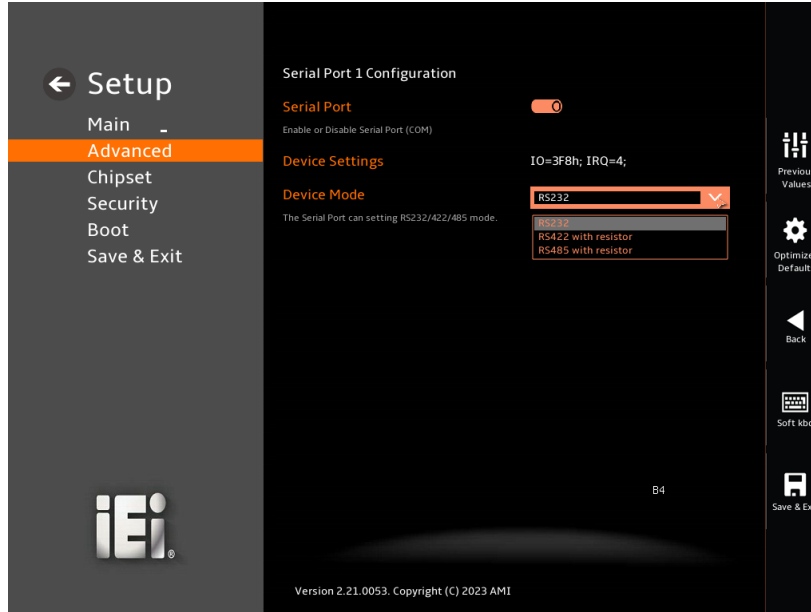

BIOS Menu 10: Serial Port 1 Configuration Menu

➔ **Serial Port [Enabled]**

Use the **Serial Port** option to enable or disable the serial port.

- ➔ **Disabled** Disable the serial port
- ➔ **Enabled DEFAULT** Enable the serial port

➔ **Device Settings**

The Device Settings option shows the serial port IO port address and interrupt address.

- ➔ **IO=3F8h;** Serial Port I/O port address is 3F8h and the interrupt
IRQ=4 address is IRQ4

➔ **Serial Port Mode**

- ➔ **RS232** The serial port mode is RS-232
- RS422** The serial port mode is RS-422
- RS485** The serial port mode is RS-485

5.3.4.2 Serial Port 2 Configuration

Use the **Serial Port 2 Configuration** menu (**BIOS Menu 11**) to configure the serial port n.

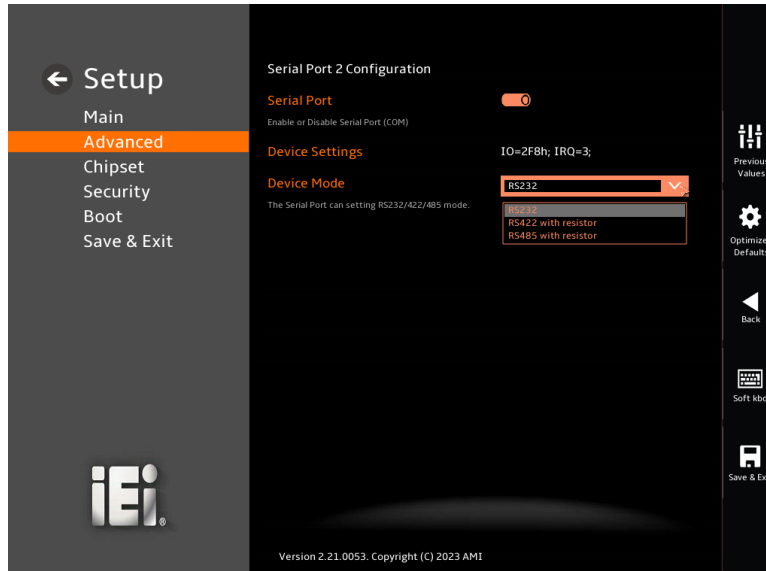

BIOS Menu 11: Serial Port 2 Configuration Menu

➔ Serial Port [Enabled]

Use the **Serial Port** option to enable or disable the serial port.

- ➔ **Disabled** Disable the serial port
- ➔ **Enabled DEFAULT** Enable the serial port

➔ Device Settings

The Device Settings option shows serial port IO port address and interrupt address.

- ➔ **IO=2F8h;** Serial Port I/O port address is 2F8h and the interrupt
IRQ=3 address is IRQ3

➔ Device Mode

- ➔ **RS232** The serial port mode is RS-232
- RS422** The serial port mode is RS-422 with resistor
- RS485** The serial port mode is RS-485 with resistor

5.3.4.3 Serial Port 3 Configuration

Use the **Serial Port 3 Configuration** menu (**BIOS Menu 12**) to configure the serial port n.

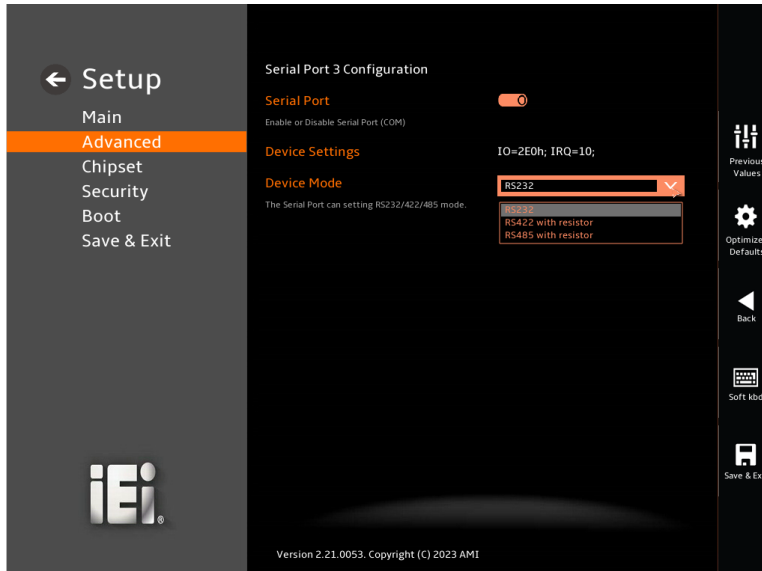

BIOS Menu 12: Serial Port 3 Configuration Menu

➔ **Serial Port [Enabled]**

Use the **Serial Port** option to enable or disable the serial port.

- ➔ **Disabled** Disable the serial port
- ➔ **Enabled DEFAULT** Enable the serial port

➔ **Device Settings**

The Device Settings option shows serial port IO port address and interrupt address.

- ➔ **IO=2E0h;** Serial Port I/O port address is 2E0h and the interrupt
- IRQ=10** address is IRQ10

DRPC-140-EHL

→ Device Mode

- **RS232** The serial port mode is RS-232
- RS422** The serial port mode is RS-422 with resistor
- RS485** The serial port mode is RS-485 with resistor

5.3.4.4 Serial Port 4 Configuration

Use the **Serial Port 4 Configuration** menu (**BIOS Menu 13**) to configure the serial port n.

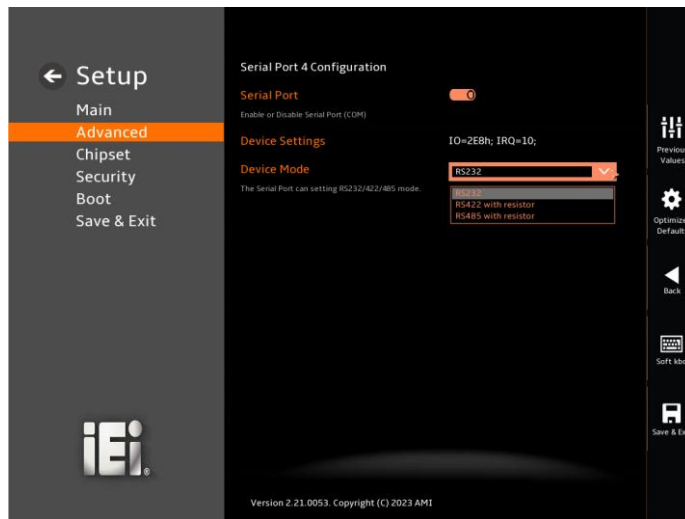

BIOS Menu 13: Serial Port 4 Configuration Menu

→ Serial Port [Enabled]

Use the **Serial Port** option to enable or disable the serial port.

- **Disabled** Disable the serial port
- **Enabled** **DEFAULT** Enable the serial port

→ Device Settings

The Device Settings option shows serial port IO port address and interrupt address.

→ **IO=2E8h;**
IRQ=10

Serial Port I/O port address is 2E8h and the interrupt address is IRQ10

→ **Device Mode**

→ **RS232**
RS422
RS485

The serial port mode is RS-232

The serial port mode is RS-422 with resistor

The serial port mode is RS-485 with resistor

DRPC-140-EHL

5.3.5 ENE KB9068 H/W Monitor

The **ENE KB9068 H/W Monitor** menu (**BIOS Menu 14**) contains the state of H/W real-time operating temperature and system voltages

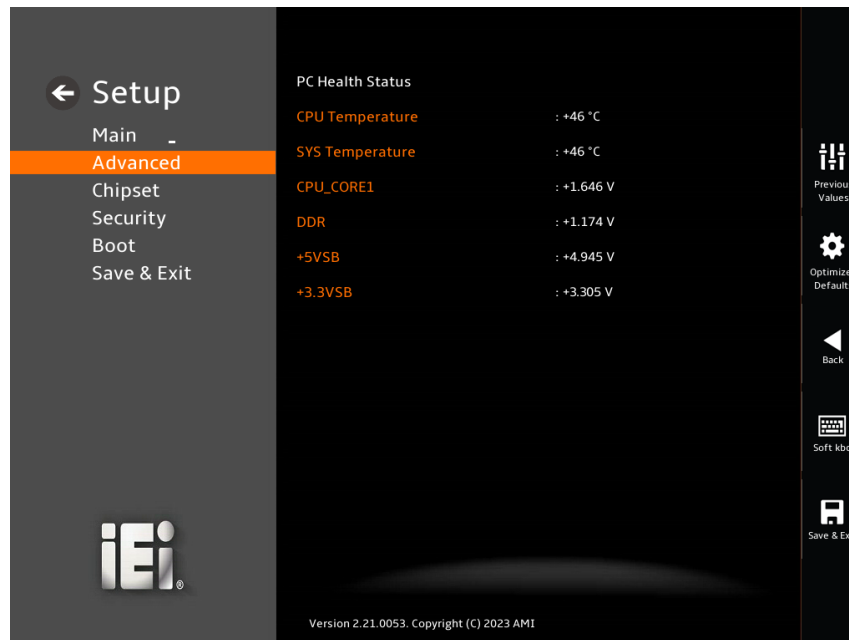

BIOS Menu 14: IT5571 H/W Monitor

→ PC Health Status

The following system parameters and values are shown. The system parameters that are monitored are:

- CPU Temperature
- System Temperature
- CPU_CORE1
- DDR
- +5VSB
- +3.3VSB

5.3.6 Serial Port Console Redirection

The **Serial Port Console Redirection** menu (**BIOS Menu 15**) allows the console redirection options to be configured. Console Redirection allows users to maintain a system remotely by re-directing keyboard input and text output through the serial port.

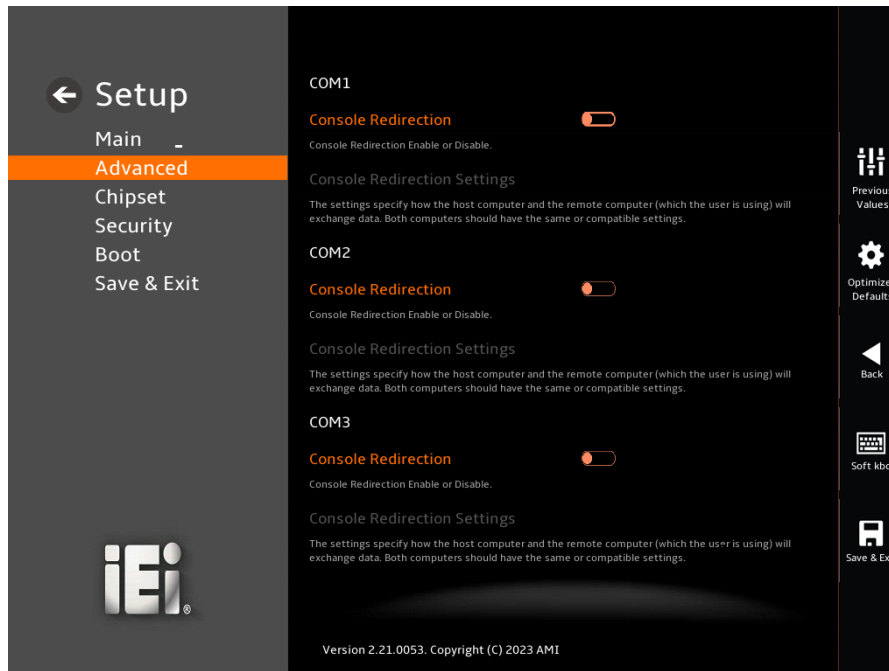

BIOS Menu 15:Serial Port Console Redirection

➔ **Console Redirection [Disabled]**

Use **Console Redirection** option to enable or disable the console redirection function.

- ➔ **Disabled** **DEFAULT** Disabled the console redirection function.
- ➔ **Enabled** Enabled the console redirection function.

The **Console Redirection Settings** submenu will be available when the **Console Redirection** option is enabled.

5.3.6.1 Console Redirection Settings

The following options are available in the **Console Redirection Settings** submenu (**BIOS Menu 16**) when the **COM Console Redirection** (for COM1 to COM4) option is enabled.

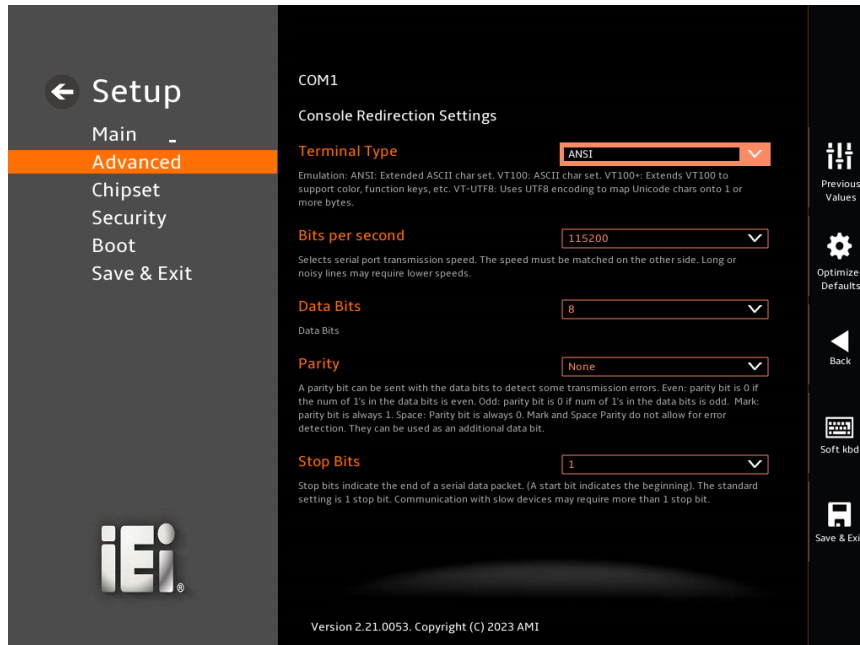

BIOS Menu 16: COM Console Redirection Settings

→ Terminal Type [ANSI]

Use the **Terminal Type** option to specify the remote terminal type.

- **VT100** The target terminal type is VT100
- **VT100+** The target terminal type is VT100+
- **VT-UTF8** The target terminal type is VT-UTF8
- **ANSI** **DEFAULT** The target terminal type is ANSI

→ Bits per second [115200]

Use the **Bits per second** option to specify the serial port transmission speed. The speed must match on the other side. Long or noisy lines may require lower speeds.

- **9600** Sets the serial port transmission speed at 9600.

- **19200** Sets the serial port transmission speed at 19200.
- **38400** Sets the serial port transmission speed at 38400.
- **57600** Sets the serial port transmission speed at 57600.
- **115200** **DEFAULT** Sets the serial port transmission speed at 115200.

→ **Data Bits [8]**

Use the **Data Bits** option to specify the number of data bits.

- **7** Sets the data bits at 7.
- **8** **DEFAULT** Sets the data bits at 8.

→ **Parity [None]**

Use the **Parity** option to specify the parity bit that can be sent with the data bits for detecting the transmission errors.

- **None** **DEFAULT** No parity bit is sent with the data bits.
- **Even** The parity bit is 0 if the number of ones in the data bits is even.
- **Odd** The parity bit is 0 if the number of ones in the data bits is odd.
- **Mark** The parity bit is always 1. This option does not allow for error detection.
- **Space** The parity bit is always 0. This option does not allow for error detection.

→ **Stop Bits [1]**

Use the **Stop Bits** option to specify the number of stop bits used to indicate the end of a serial data packet. Communication with slow devices may require more than 1 stop bit.

- **1** **DEFAULT** Sets the number of stop bits at 1.
- **2** Sets the number of stop bits at 2.

5.3.7 NVMe Configuration

Use the **NVMe Configuration (BIOS Menu 17)** menu to display the NVMe controller.

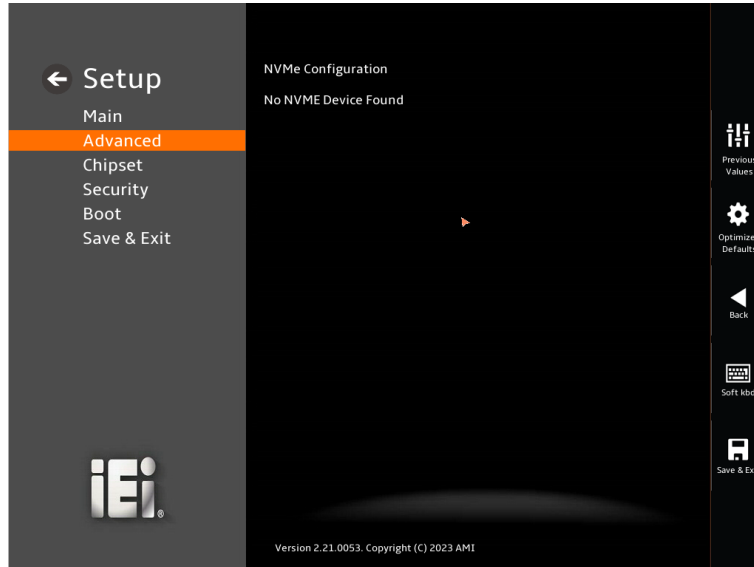

BIOS Menu 17: NVMe configuration

5.4 Chipset

Use the **Chipset** menu (**BIOS Menu 18**) to access the PCH IO and System Agent (SA) configuration menus.



WARNING!

Setting the wrong values for the Chipset BIOS selections in the Chipset BIOS menu may cause the system to malfunction.

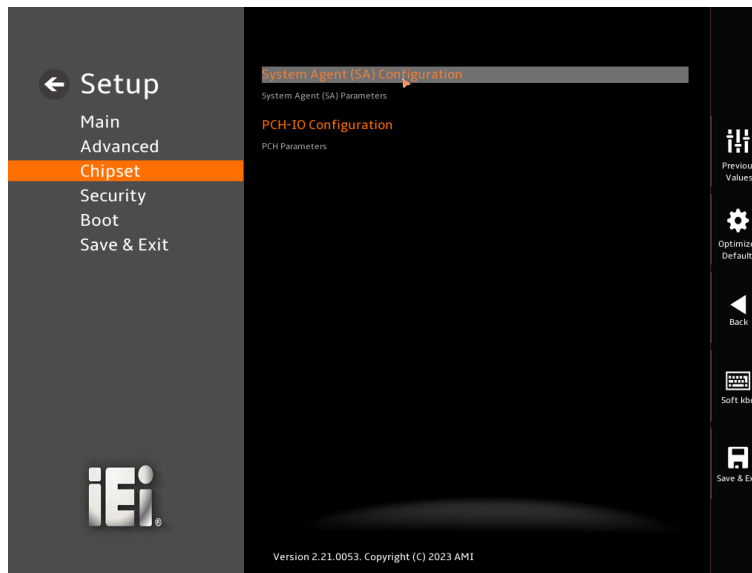

BIOS Menu 18: Chipset

5.4.1 System Agent (SA) Configuration

Use the **System Agent (SA) Configuration** menu (**BIOS Menu 19**) to configure the System Agent (SA) parameters.

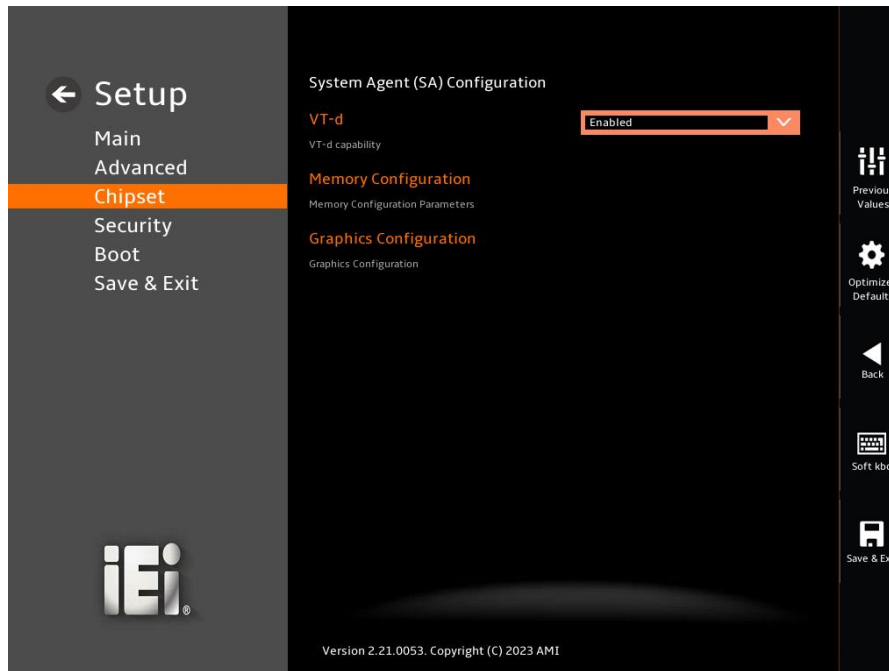

BIOS Menu 19: System Agent (SA) Configuration

→ VT-d [Enabled]

Use the **VT-d** option to enable or disable the VT-d capability.

- **Disabled** Disable the VT-d capability
- **Enabled** **DEFAULT** Enable the VT-d capability

5.4.1.1 Memory Configuration

Use the **Memory Configuration** submenu (**BIOS Menu 20**) to view memory information.



BIOS Menu 20: Memory Configuration

5.4.1.2 Graphics Configuration

Use the **Graphics Configuration (BIOS Menu 21)** menu to view the video device connected to the system.

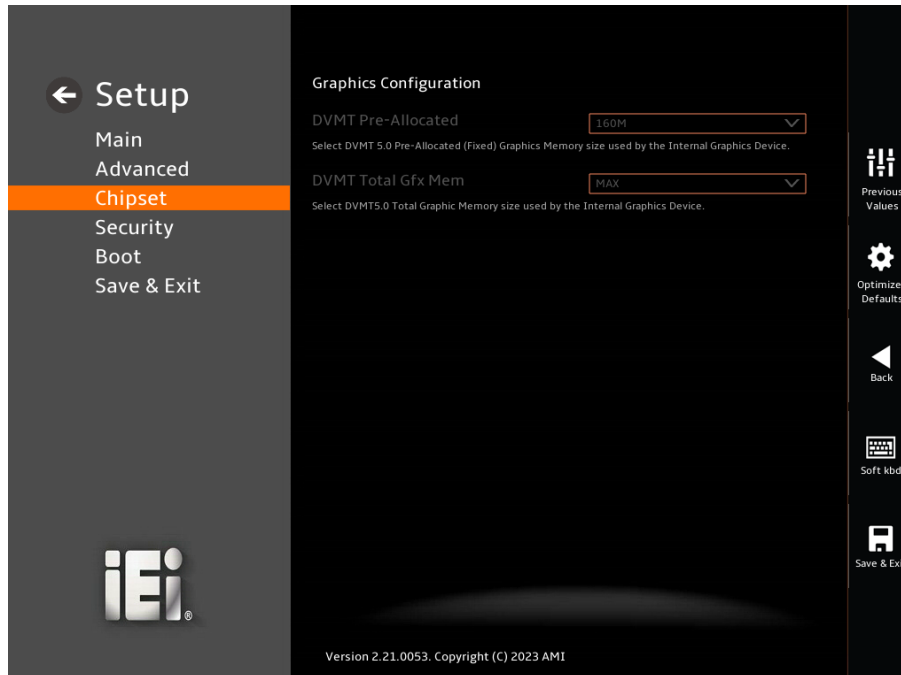

BIOS Menu 21: Graphics Configuration

5.4.2 PCH-IO Configuration

Use the **PCH-IO Configuration** menu (**BIOS Menu 22 & BIOS Menu 23**) to configure the PCH parameters.

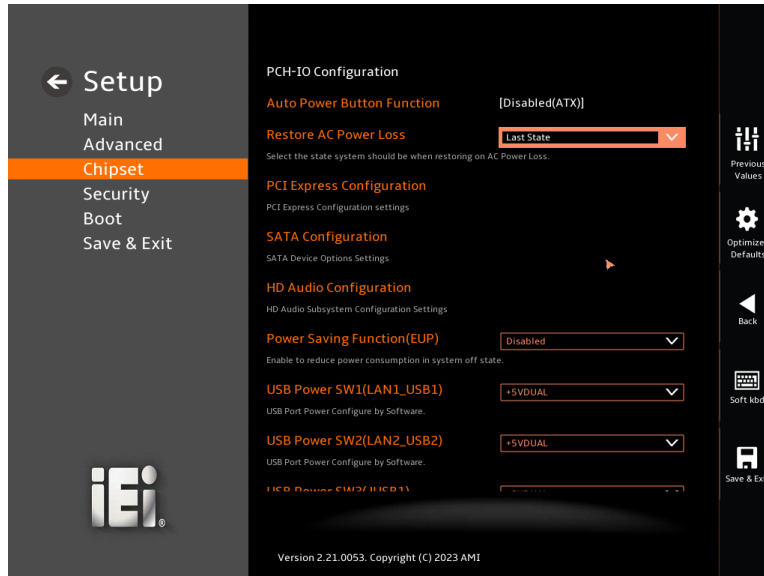

BIOS Menu 22: PCH-IO Configuration (1/2)

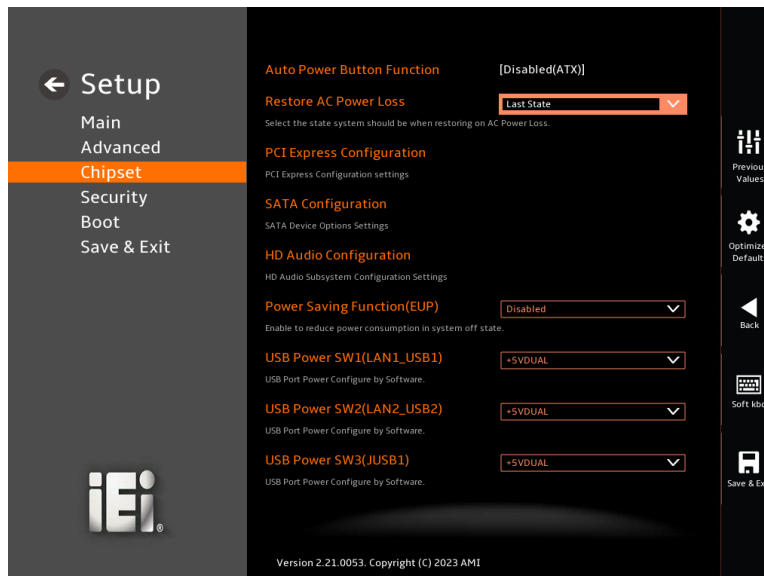

BIOS Menu 23: PCH-IO Configuration (2/2)

DRPC-140-EHL→ **Auto Power Button Function [Enabled (AT)]**

Use the **Auto Power Button Function** BIOS option to show the power mode state. Use the **J_ATX_AT1** to switch the AT/ATX power mode.

- **Enabled (AT)** The system power mode is AT.
- **Disabled (ATX)** The system power mode is ATX.

→ **Restore AC Power Loss [Last State]**

Use the **Restore AC Power Loss** BIOS option to specify what state the system returns to if there is a sudden loss of power to the system when the power mode is ATX.

- **Power Off** The system remains turned off
- **Power On** The system turns on
- **Last State** **DEFAULT** The system returns to its previous state. If it was on, it turns itself on. If it was off, it remains off.

→ **Power Saving Function (EUP) [Disabled]**

Use the **Power Saving Function (EUP)** BIOS option to enable or disable the power saving function.

- **Disabled** **DEFAULT** Power saving function is disabled.
- **Enabled** Power saving function is enabled. It will reduce power consumption when the system is off.

→ **USB Power SW1 [+5V DUAL]**

Use the **USB Power SW1** BIOS option to configure the USB power source for the corresponding USB connectors (Figure 5-4).

- **+5V DUAL** **DEFAULT** Sets the USB power source to +5V dual
- **+5V** Sets the USB power source to +5V

5.4.2.1 PCI Express Configuration

Use the **PCI Express Configuration** submenu (**BIOS Menu 24**) to configure the PCI Express slots.

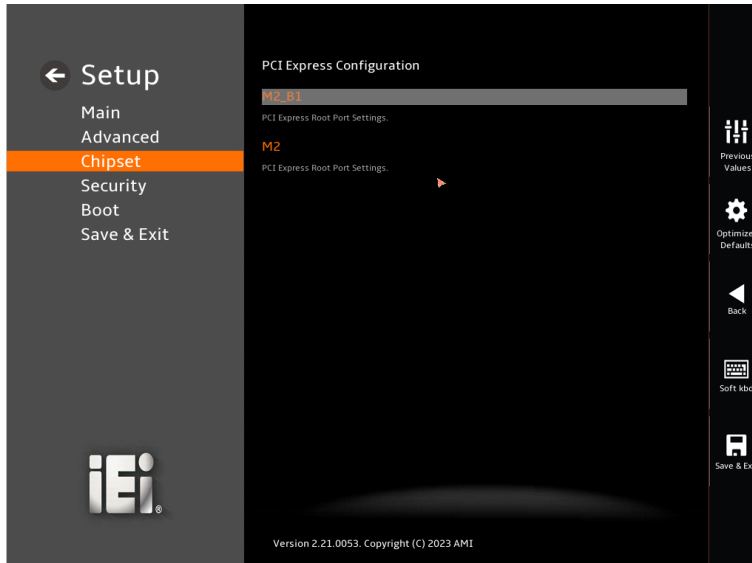

BIOS Menu 24: PCI Express Configuration

5.4.2.2 PCI Express Root Port Setting

Use the **M2_A1** and **M.2_M1** submenu (**BIOS Menu 25**) to configure the PCI Root Port Setting.



BIOS Menu 25: PCI Express Root Port Configuration

→ PCIe Speed [Auto]

Use the **PCIe Speed** option to specify the PCI Express port speed. Configuration options are listed below.

- **Auto** **DEFAULT** Auto mode.
- **Gen1** Configure PCIe Speed to Gen1.
- **Gen2** Configure PCIe Speed to Gen2.
- **Gen3** Configure PCIe Speed to Gen3.

→ Detect Non-Compliance Device [Disabled]

Use the **Detect Non-Compliance Device** option to configure whether to detect if a non-compliance PCI Express device is connected to the PCI Express port.

DRPC-140-EHL

- | | | | |
|---|-----------------|----------------|--|
| ➔ | Disabled | DEFAULT | Do not detect if a non-compliance PCI Express device is connected to the PCI Express port. |
| ➔ | Enabled | | Detect if a non-compliance PCI Express device is connected to the PCI Express port. |

5.4.2.3 SATA Configuration

Use the **SATA Configuration** menu (**BIOS Menu 26**) to change and/or set the configuration of the SATA devices installed in the system.



BIOS Menu 26: SATA Configuration

➔ **SATA Controller(s) [Enabled]**

Use the **SATA Controller(s)** option to enable or disable SATA device.

- ➔ **Enabled** **DEFAULT** Enabled SATA device.
- ➔ **Disabled** Disabled SATA device.

➔ **SATA Mode Selection [AHCI]**

Use the **SATA Mode Selection** option to determine how the SATA devices operate.

- ➔ **AHCI** **DEFAULT** Configures SATA devices as AHCI device.

DRPC-140-EHL

→ Hot Plug [Disabled]

Use the **Hot Plug** option to designate the correspondent port as hot-pluggable.

- **Disabled** **DEFAULT** Disables the hot-pluggable function of the SATA port.
- **Enabled** Designate the SATA port as hot-pluggable

5.4.2.4 HD Audio Configuration

Use the **HD Audio Configuration** menu (**BIOS Menu 27**) to configure the PCH Azalia settings.

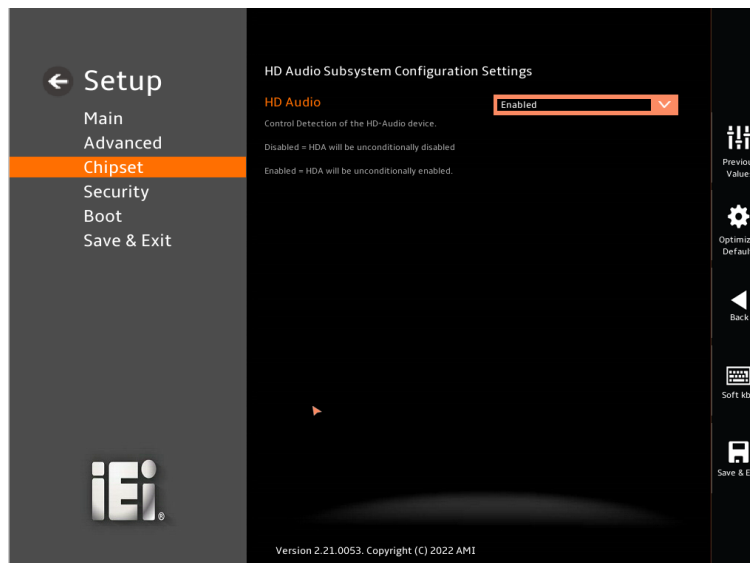

BIOS Menu 27: HD Audio Configuration

→ HD Audio [Enabled]

Use the **HD Audio** option to enable or disable the High Definition Audio controller.

- **Disabled** The onboard High Definition Audio controller is disabled.
- **Enabled** **DEFAULT** The onboard High Definition Audio controller is enabled.

5.5 Security

Use the **Security** menu (**BIOS Menu 28 & BIOS Menu 29**) to set system and user passwords.



BIOS Menu 28: Security (1/2)

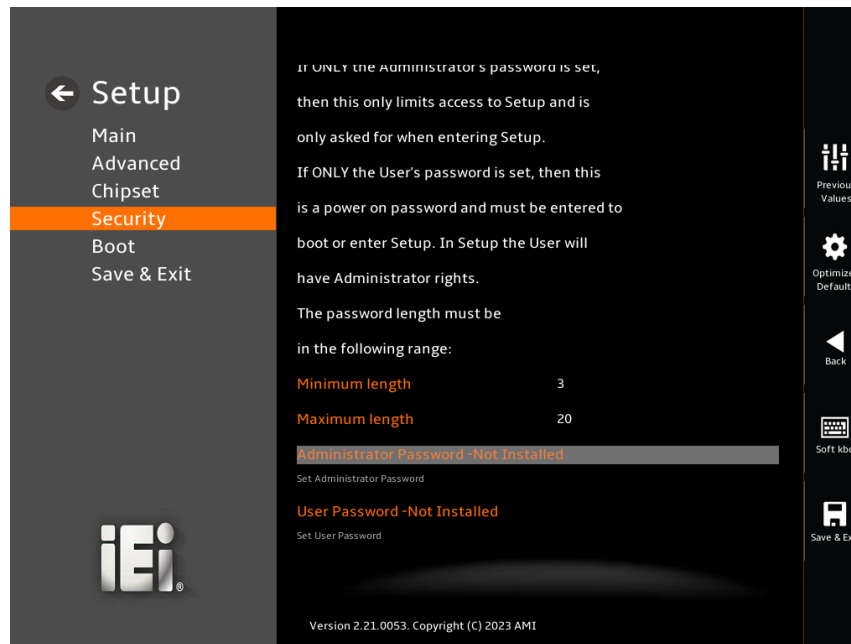

BIOS Menu 29: Security (2/2)

DRPC-140-EHL

→ **Administrator Password**

Use the **Administrator Password** to set or change a administrator password.

→ **User Password**

Use the **User Password** to set or change a user password.

5.6 Boot

Use the **Boot** menu (**BIOS Menu 30**) to configure system boot options.

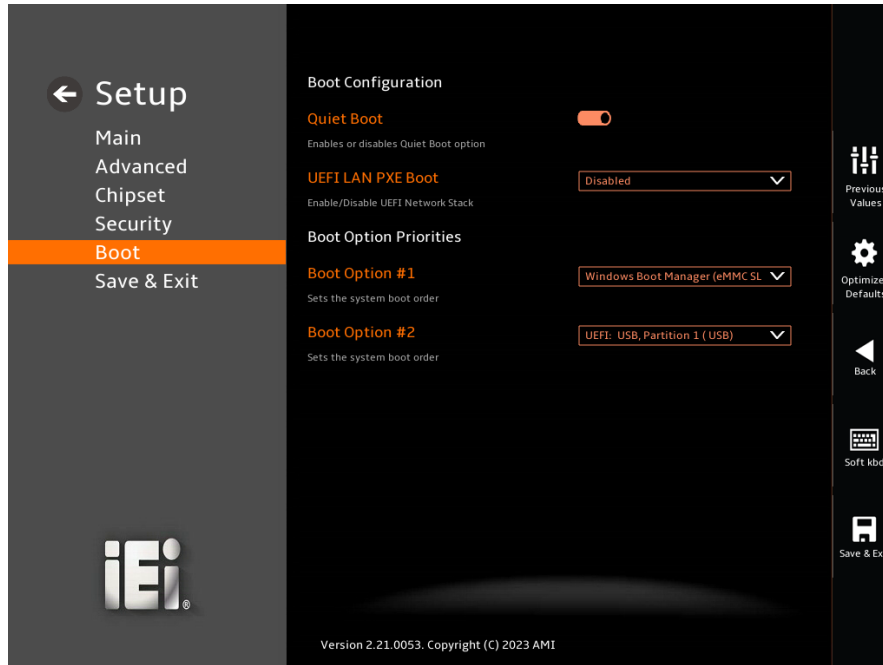

BIOS Menu 30: Boot

5.6.1 Boot Configuration

→ Quiet Boot [Enabled]

Use the **Quiet Boot** BIOS option to select the screen display when the system boots.

- **Disabled** Normal POST messages displayed
- **Enabled** **DEFAULT** OEM Logo displayed instead of POST messages

→ UEFI LAN PXE BOOT [Disabled]

Use the **UEFI LAN PXE BOOT** option to enable or disable UEFI network stack.

- **Disabled** **DEFAULT** Ignore all PXE Option ROMs
- **Enabled** Load PXE Option ROMs.

DRPC-140-EHL**5.6.2 Boot Option Priorities**

Use the Boot Option # N to choose the system boots from the peripherals you selected.
The following Boot Options are listed as an example.

→ Boot Option #1

Sets the system boot order **ADATA SP580** as the first priority.

- Windows Boot Manager (P1: ADATA SSD SP580 240GB)**
- Disabled**

→ Boot Option #2

Sets the system boot order **USB Partition 1** as the second priority.

- UEFI: USB, Partition 1**
- Disabled**

5.7 Save & Exit

Use the **Save & Exit** menu (**BIOS Menu 31**) to load default BIOS values, optimal failsafe values and to save configuration changes.

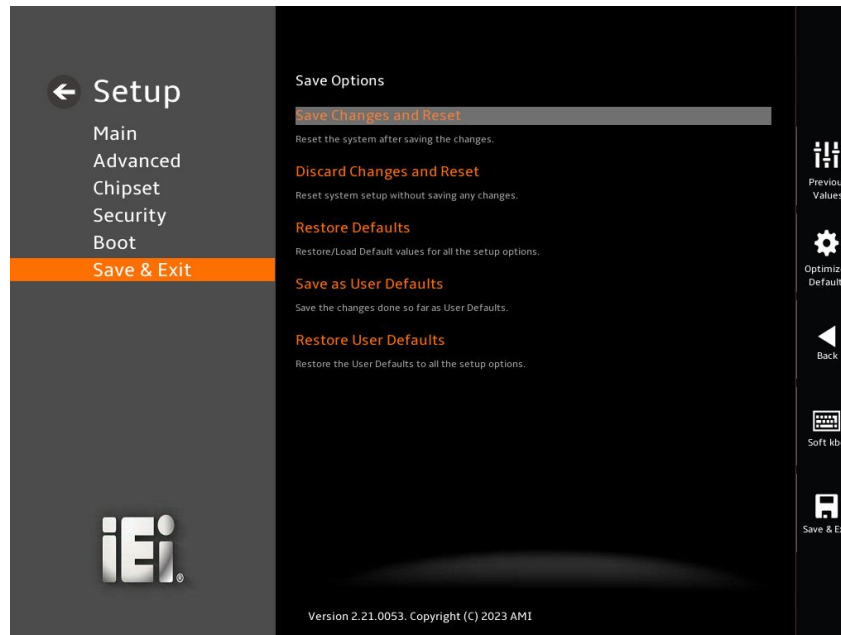

BIOS Menu 31: Save & Exit

→ Save Changes and Reset

Use the **Save Changes and Reset** option to save the changes made to the BIOS options and reset the system.

→ Discard Changes and Reset

Use the **Discard Changes and Reset** option to exit the system without saving the changes made to the BIOS configuration setup program.

→ Restore Defaults

Use the **Restore Defaults** option to load the optimal default values for each of the parameters on the Setup menus. **F3 key can be used for this operation.**

→ Save as User Defaults

Use the **Save as User Defaults** option to save the changes done so far as user defaults.

DRPC-140-EHL

→ Restore User Defaults

Use the **Restore User Defaults** option to restore the user defaults to all the setup options.

Appendix

A

Safety Precautions

A.1 Safety Precautions



WARNING:

The precautions outlined in this appendix should be strictly followed. Failure to follow these precautions may result in permanent damage to the DRPC-140-EHL Series.

Please follow the safety precautions outlined in the sections that follow:

A.1.1 General Safety Precautions

Please ensure the following safety precautions are adhered to at all times.

- ***Make sure the power is turned off and the power cord is disconnected*** when moving, installing or modifying the system.
- ***Do not apply voltage levels that exceed the specified voltage range.*** Doing so may cause fire and/or an electrical shock.
- ***Electric shocks can occur*** if opened while still powered on.
- ***Do not drop or insert any objects*** into the ventilation openings.
- ***If considerable amounts of dust, water, or fluids enter the system***, turn off the power supply immediately, unplug the power cord, and contact the system vendor.
- ***This equipment is not suitable for use in locations where children are likely to be present.***
- **DO NOT:**
 - Drop the system against a hard surface.
 - In a site where the ambient temperature exceeds the rated temperature

A.1.2 Anti-static Precautions

**WARNING:**

Failure to take ESD precautions during the installation of the DRPC-140-EHL Series may result in permanent damage to the DRPC-140-EHL Series and severe injury to the user.

Electrostatic discharge (ESD) can cause serious damage to electronic components, including the DRPC-140-EHL Series. Dry climates are especially susceptible to ESD. It is therefore critical that whenever the DRPC-140-EHL Series is opened and any of the electrical components are handled, the following anti-static precautions are strictly adhered to.

- ***Wear an anti-static wristband:*** Wearing a simple anti-static wristband can help to prevent ESD from damaging any electrical component.
- ***Self-grounding:*** Before handling any electrical component, touch any grounded conducting material. During the time the electrical component is handled, frequently touch any conducting materials that are connected to the ground.
- ***Use an anti-static pad:*** When configuring or working with an electrical component, place it on an anti-static pad. This reduces the possibility of ESD damage.

A.1.3 Product Disposal

**CAUTION:**

Risk of explosion if the battery is replaced by an incorrect type;

Replacement of a battery with an incorrect type that can defeat a safeguard (for example, in the case of some lithium battery types);

Disposal of a battery into fire or a hot oven, or mechanically crushing or cutting of a battery, that can result in an explosion;

Leaving a battery in an extremely high temperature surrounding environment that can result in an explosion or the leakage of flammable liquid or gas;

A battery subjected to extremely low air pressure that may result in an explosion or the leakage of flammable liquid or gas.

Dispose of used batteries according to instructions and local regulations.

- Outside the European Union - If you wish to dispose of used electrical and electronic products outside the European Union, please contact your local authority so as to comply with the correct disposal method.
- Within the European Union:

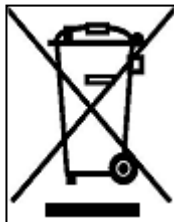

EU-wide legislation, as implemented in each Member State, requires that waste electrical and electronic products carrying the mark (left) must be disposed of separately from normal household waste. This includes monitors and electrical accessories, such as signal cables or power cords.

When you need to dispose of your display products, please follow the guidance of your local authority, or ask the shop where you purchased the product. The mark on electrical and electronic products only applies to the current European Union Member States.

Please follow the national guidelines for electrical and electronic product disposal.

A.2 Maintenance and Cleaning Precautions

When maintaining or cleaning the DRPC-140-EHL Series, please follow the guidelines below.

A.2.1 Maintenance and Cleaning

Prior to cleaning any part or component of the DRPC-140-EHL Series, please read the details below.

- The interior of the DRPC-140-EHL Series does not require cleaning. Keep fluids away from the DRPC-140-EHL Series interior.
- Be cautious of all small removable components when vacuuming the DRPC-140-EHL Series.
- Turn the DRPC-140-EHL Series off before cleaning the DRPC-140-EHL Series.
- Never drop any objects or liquids through the openings of the DRPC-140-EHL Series.
- Be cautious of any possible allergic reactions to solvents or chemicals used when cleaning the DRPC-140-EHL Series.

A.2.2 Cleaning Tools

Some components in the DRPC-140-EHL Series may only be cleaned using a product specifically designed for the purpose. In such case, the product will be explicitly mentioned in the cleaning tips. Below is a list of items to use when cleaning the DRPC-140-EHL Series.

- **Cloth** – Although paper towels or tissues can be used, a soft, clean piece of cloth is recommended when cleaning the DRPC-140-EHL Series.
- **Water or rubbing alcohol** – A cloth moistened with water or rubbing alcohol can be used to clean the DRPC-140-EHL Series.
- **Using solvents** – The use of solvents is not recommended when cleaning the DRPC-140-EHL Series as they may damage the plastic parts.
- **Vacuum cleaner** – Using a vacuum specifically designed for computers is one of the best methods of cleaning the DRPC-140-EHL Series. Dust and dirt

DRPC-140-EHL

can restrict the airflow in the DRPC-140-EHL Series and cause its circuitry to corrode.

- **Swabs** - Swabs moistened with rubbing alcohol or water are excellent tools for wiping hard to reach areas. Whenever possible, it is best to use lint free swabs such as foam swabs for cleaning.

Appendix

B

Regulatory Compliance

DECLARATION OF CONFORMITY

This equipment is in conformity with the following EU directives:

- EMC Directive 2014/30/EU
- Low-Voltage Directive 2014/35/EU
- RoHS II Directive 2015/863/EU

If the user modifies and/or install other devices in the equipment, the CE conformity declaration may no longer apply.

If this equipment has telecommunications functionality, it also complies with the requirements of the R&TTE Directive 1999/5/EC.

English

IEI Integration Corp declares that this equipment is in compliance with the essential requirements and other relevant provisions of Directive 1999/5/EC.

Български [Bulgarian]

IEI Integration Corp. декларира, че този оборудване е в съответствие със съществените изисквания и другите приложими правила на Директива 1999/5/EC.

Česky [Czech]

IEI Integration Corp tímto prohlašuje, že tento zařizení je ve shodě se základními požadavky a dalšími příslušnými ustanoveními směrnice 1999/5/ES.

Dansk [Danish]

IEI Integration Corp erklærer herved, at følgen e udstyr overholder de væsentlige krav og øvrige relevante krav i direktiv 1999/5/EF.

Deutsch [German]

IEI Integration Corp, erklärt dieses Gerät entspricht den grundlegenden Anforderungen und den weiteren entsprechenden Vorgaben der Richtlinie 1999/5/EU.

Eesti [Estonian]

IEI Integration Corp deklareerib seadme seadme vastavust direktiivi 1999/5/EÜ põhinõuetele ja nimetatud direktiivist tulenevatele teistele asjakohastele sätetele.

Español [Spanish]

IEI Integration Corp declara que el equipo cumple con los requisitos esenciales y cualesquiera otras disposiciones aplicables o exigibles de la Directiva 1999/5/CE.

Ελληνική [Greek]

IEI Integration Corp ΔΗΛΩΝΕΙ ΟΤΙ ΕΞΟΠΛΙΣΜΟΣ ΣΥΜΜΟΡΦΩΝΕΤΑΙ ΠΡΟΣ ΤΙΣ ΟΥΣΙΩΔΕΙΣ ΑΠΑΙΤΗΣΕΙΣ ΚΑΙ ΤΙΣ ΛΟΙΠΕΣ ΣΧΕΤΙΚΕΣ ΔΙΑΤΑΞΕΙΣ ΤΗΣ ΟΔΗΓΙΑΣ 1999/5/ΕΚ.

Français [French]

IEI Integration Corp déclare que l'appareil est conforme aux exigences essentielles et aux autres dispositions pertinentes de la directive 1999/5/CE.

Italiano [Italian]

IEI Integration Corp dichiara che questo apparecchio è conforme ai requisiti essenziali ed alle altre disposizioni pertinenti stabilite dalla direttiva 1999/5/CE.

Latviski [Latvian]

IEI Integration Corp deklarē, ka iekārta atbilst būtiskajām prasībām un citiem ar to saistītajiem noteikumiem Direktīvas 1999/5/ΕΚ.

Lietuvių [Lithuanian]

IEI Integration Corp deklaruoja, kad šis įranga atitinka esminius reikalavimus ir kitas 1999/5/EB Direktyvos nuostatas.

Nederlands [Dutch]

IEI Integration Corp dat het toestel toestel in overeenstemming is met de essentiële eisen en de andere relevante bepalingen van richtlijn 1999/5/EG.

Malti [Maltese]

IEI Integration Corp jiddikjara li dan prodott jikkonforma mal-ħtiġijiet essenzjali u ma provvedimenti oħrajn relevanti li hemm fid-Direttiva 1999/5/EC.

Magyar [Hungarian]

IEI Integration Corp nyilatkozik, hogy a berendezés megfelel a vonatkozó alapvető követelményeknek és az 1999/5/EC irányelv egyéb előírásainak.

Polski [Polish]

IEI Integration Corp oświadcza, że wyrobu jest zgodny z zasadniczymi wymogami oraz pozostałymi stosownymi postanowieniami Dyrektywy 1999/5/EC.

Português [Portuguese]

IEI Integration Corp declara que este equipamento está conforme com os requisitos essenciais e outras disposições da Directiva 1999/5/CE.

Româna [Romanian]

IEI Integration Corp declară că acest echipament este în conformitate cu cerințele esențiale și cu celelalte prevederi relevante ale Directivei 1999/5/CE.

Slovensko [Slovenian]

IEI Integration Corp izjavlja, da je ta opreme v skladu z bistvenimi zahtevami in ostalimi relevantnimi določili direktive 1999/5/ES.

DRPC-140-EHL

Slovensky [Slovak]

IEI Integration Corp týmto vyhlasuje, že zariadenia spĺňa základné požiadavky a všetky príslušné ustanovenia Smernice 1999/5/ES.

Suomi [Finnish]

IEI Integration Corp vakuuttaa täten että Iitteet on direktiivin 1999/5/EY oleellisten vaatimusten ja sitä koskevien direktiivin muiden ehtojen mukainen.

Svenska [Swedish]

IEI Integration Corp förklarar att denna utrustningstyp står i överensstämmelse med de väsentliga egenskapskrav och övriga relevanta bestämmelser som framgår av direktiv 1999/5/EG.

ROHS STATEMENT



The label on the product indicates this product conforms to European (EU) Restriction of Hazardous Substances (RoHS) that set maximum concentration limits on hazardous materials used in electrical and electronic equipment.

FCC WARNING

This equipment complies with Part 15 of the FCC Rules. Operation is subject to the following two conditions:

- This device may not cause harmful interference, and
- This device must accept any interference received, including interference that may cause undesired operation.

This equipment has been tested and found to comply with the limits for a Class A digital device, pursuant to part 15 of the FCC Rules. These limits are designed to provide reasonable protection against harmful interference when the equipment is operated in a commercial environment. This equipment generates, uses, and can radiate radio frequency energy and, if not installed and used in accordance with the instruction manual, may cause harmful interference to radio communications. Operation of this equipment in a residential area is likely to cause harmful interference in which case the user will be required to correct the interference at his own expense.

Any changes or modifications not expressly approved by the party responsible for compliance could void the user's authority to operate the equipment.

This equipment complies with FCC radiation exposure limits set forth for an uncontrolled environment. This equipment should be installed and operated with a minimum distance of 20cm between the radiator & your body.

CHINA ROHS

The label on the product indicates the estimated “Environmentally Friendly Use Period” (EFUP). This is an estimate of the number of years that these substances would “not leak out or undergo abrupt change.” This product may contain replaceable sub-assemblies/components which have a shorter EFUP such as batteries and lamps. These components will be separately marked.

Appendix

C

BIOS Menu Options

Below is a list of BIOS configuration options in the BIOS chapter.

- ➔ **BIOS Information60**
- ➔ **Compute Die Information60**
- ➔ **PCH Information.....60**
- ➔ **System Date [xx:xx:xx].....61**
- ➔ **System Time [xx:xx:xx]61**
- ➔ **TPM Support [Enable]67**
- ➔ **Pending Operation [None]67**
- ➔ **Wake system with Fixed Time [Disabled].....68**
- ➔ **Serial Port [Enabled].....70**
- ➔ **Device Settings70**
- ➔ **Serial Port Mode.....70**
- ➔ **Serial Port [Enabled].....71**
- ➔ **Device Settings71**
- ➔ **Device Mode71**
- ➔ **Serial Port [Enabled].....72**
- ➔ **Device Settings72**
- ➔ **Device Mode73**
- ➔ **Serial Port [Enabled].....73**
- ➔ **Device Settings73**
- ➔ **Device Mode74**
- ➔ **PC Health Status75**
- ➔ **Console Redirection [Disabled].....76**
- ➔ **Terminal Type [ANSI].....77**
- ➔ **Bits per second [115200].....77**
- ➔ **Data Bits [8]78**
- ➔ **Parity [None].....78**
- ➔ **Stop Bits [1]78**
- ➔ **VT-d [Enabled].....81**
- ➔ **Auto Power Button Function [Enabled (AT)]85**
- ➔ **Restore AC Power Loss [Last State]85**
- ➔ **Power Saving Function (EUP) [Disabled].....85**
- ➔ **USB Power SW1 [+5V DUAL].....85**
- ➔ **USB Power SW2 [+5V DUAL].....86**

DRPC-140-EHL

→ USB Power SW3 [+5V DUAL]	86
→ PCIe Speed [Auto].....	88
→ Detect Non-Compliance Device [Disabled]	88
→ SATA Controller(s) [Enabled]	90
→ SATA Mode Selection [AHCI].....	90
→ Hot Plug [Disabled]	91
→ HD Audio [Enabled]	91
→ Administrator Password	93
→ User Password	93
→ Quiet Boot [Enabled]	94
→ UEFI LAN PXE BOOT [Disabled]	94
→ Boot Option #1	95
→ Boot Option #2	95

Appendix

D

Hazardous Materials Disclosure

DRPC-140-EHL

D.1 RoHS II Directive (2015/863/EU)

The details provided in this appendix are to ensure that the product is compliant with the RoHS II Directive (2015/863/EU). The table below acknowledges the presences of small quantities of certain substances in the product, and is applicable to RoHS II Directive (2015/863/EU).

Please refer to the following table.

Part Name	Toxic or Hazardous Substances and Elements									
	Lead (Pb)	Mercury (Hg)	Cadmium (Cd)	Hexavalent Chromium (CR(VI))	Polybrominated Biphenyls (PBBs)	Polybrominated Diphenyl Ethers (PBDEs)	Bis(2-ethylhexyl) phthalate (DEHP)	Butyl benzyl phthalate (BBP)	Dibutyl phthalate (DBP)	Diisobutyl phthalate (DIBP)
Housing	O	O	O	O	O	O	O	O	O	O
Printed Circuit Board	O	O	O	O	O	O	O	O	O	O
Metal Fasteners	O	O	O	O	O	O	O	O	O	O
Cable Assembly	O	O	O	O	O	O	O	O	O	O
Fan Assembly	O	O	O	O	O	O	O	O	O	O
Power Supply Assemblies	O	O	O	O	O	O	O	O	O	O
Battery	O	O	O	O	O	O	O	O	O	O
<p>O: This toxic or hazardous substance is contained in all of the homogeneous materials for the part is below the limit requirement in Directive (EU) 2015/863.</p> <p>X: This toxic or hazardous substance is contained in at least one of the homogeneous materials for this part is above the limit requirement in Directive (EU) 2015/863.</p>										

D.2 China RoHS

此附件旨在确保本产品符合中国 RoHS 标准。以下表格标示此产品中某有毒物质的含量符合中国 RoHS 标准规定的限量要求。

本产品上会附有“环境友好使用期限”的标签，此期限是估算这些物质“不会有泄漏或突变”的年限。本产品可能包含有较短的环境友好使用期限的可替换元件，像是电池或灯管，这些元件将会单独标示出来。

部件名称	有毒有害物质或元素					
	铅 (Pb)	汞 (Hg)	镉 (Cd)	六价铬 (CR(VI))	多溴联苯 (PBB)	多溴二苯醚 (PBDE)
壳体	○	○	○	○	○	○
印刷电路板	○	○	○	○	○	○
金属螺帽	○	○	○	○	○	○
电缆组装	○	○	○	○	○	○
风扇组装	○	○	○	○	○	○
电力供应组装	○	○	○	○	○	○
电池	○	○	○	○	○	○

○: 表示该有毒有害物质在该部件所有物质材料中的含量均在 SJ/T11364-2014 與 GB/T26572-2011 标准规定的限量要求以下。X: 表示该有毒有害物质至少在该部件的某一均质材料中的含量超出 SJ/T11364-2014 與 GB/T26572-2011 标准规定的限量要求。